

# SECURITY & SAFETY CATALOGUE





# Protect what you love

The people and things you love are important. Since 1924, ABUS has helped people worldwide protect what they love. Engineered in Germany, ABUS security products offer high quality, incredible reliability, ease of use, and a long service life.

ABUS provides a large product range of innovative solutions for home security, safety lockout/tagout, commercial security, and recreational security.

**#protectwhatyoulove**

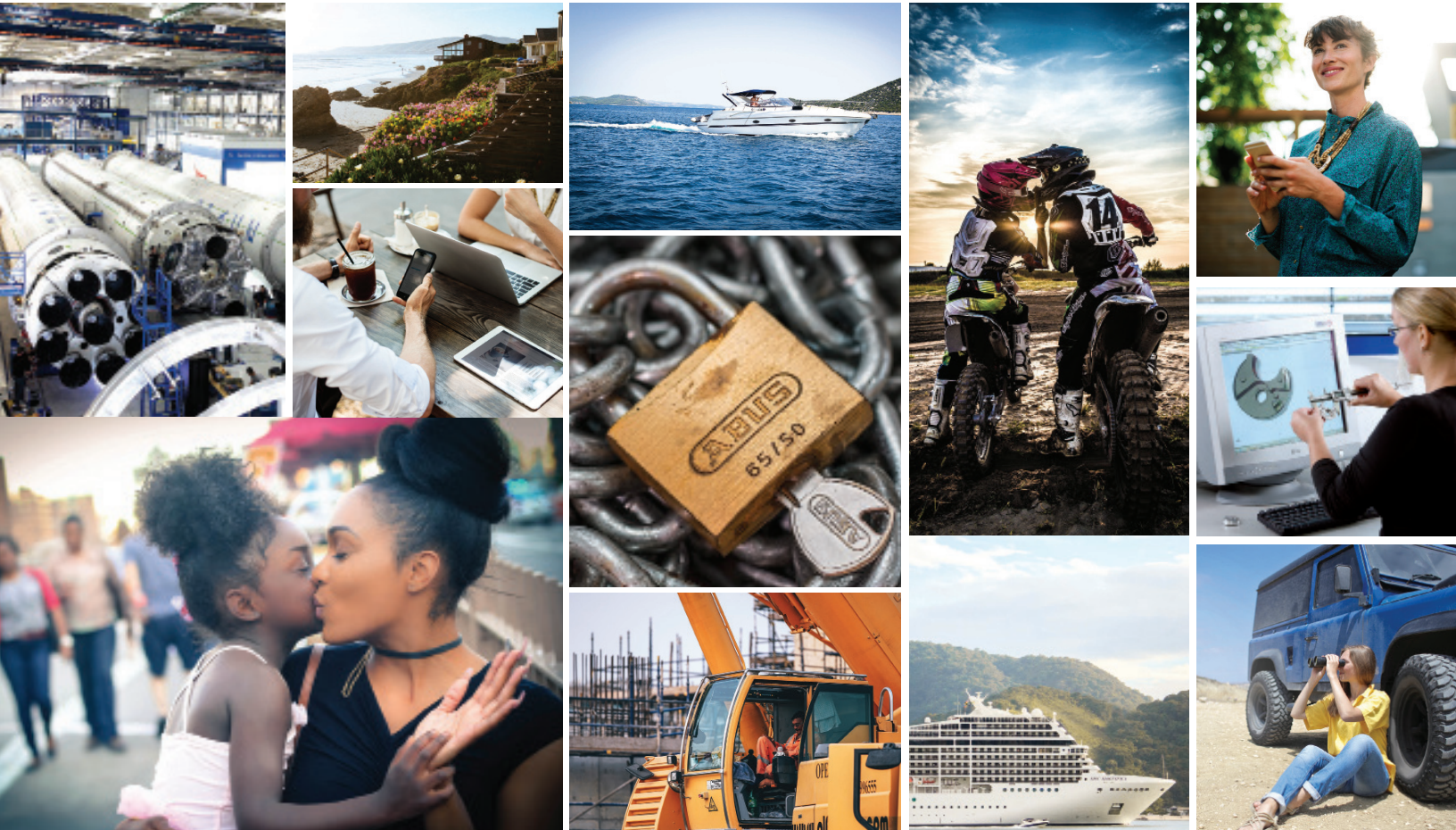



Security Tech Germany

## Customer Support

Do you have a question concerning ABUS, but don't know who to contact? We're here to help, and you can contact us in the following ways:

- Talk to us, Call us at 855-287-2287 to speak to a Customer Support representative from 8:00 a.m. to 4:30 p.m. Eastern Daylight Time.
- Email us at [sales@abuscanada.com](mailto:sales@abuscanada.com).
- Visit [www.abus.com](http://www.abus.com) to learn more about ABUS products and services.

### Length Translation

3 mm = 1/8"	20 mm = 3/4"	80 mm = 3 1/8"
4 mm = 5/32"	22 mm = 7/8"	100 mm = 4"
5 mm = 3/16"	24 mm = 15/16"	125 mm = 5"
6 mm = 15/64"	25 mm = 1"	150 mm = 6"
6.5 mm = 1/4"	27 mm = 1 1/16"	200 mm = 7 7/8"
7 mm = 9/32"	29 mm = 1 1/8"	250 mm = 9 27/32"
8 mm = 5/16"	30 mm = 1 3/16"	300 mm = 11 13/16"
9 mm = 118/32"	35 mm = 1 3/8"	350 mm = 13 25/32"
9.5 mm = 3/8"	38 mm = 1 1/2"	400 mm = 15 3/4"
10 mm = 25/64"	40 mm = 1 1/2"	450 mm = 17 23/32"
11 mm = 7/16"	43 mm = 1 11/16"	500 mm = 19 11/16"
11.5 mm = 29/64"	45 mm = 1 3/4"	550 mm = 21 21/32"
12 mm = 15/32"	50 mm = 2"	600 mm = 23 5/8"
13 mm = 1/2"	55 mm = 2 3/16"	1000 mm = 3.3'
14 mm = 9/16"	60 mm = 2 3/8"	2000 mm = 6.5'
15 mm = 19/32"	65 mm = 2 1/2"	3000 mm = 9.8'
17 mm = 21/32"	70 mm = 2 3/4"	5000 mm = 16.4'
18 mm = 23/32"	75 mm = 3"	

Safety Padlocks 6

Safety Devices 10

Safety Kits + Stations 20

High Security Padlocks 25

Industrial Padlocks 35

Hasps 53

Accessories 56

Vites<sup>TM</sup> High Security 60

General Information 70

Charting, Merchandising,  
ULE Validation, Icon Glossary,  
Key Blank Chart, Terms &  
Conditions, 90 Yrs of Innovation



# Safe Workplace, Protected Employees

Often taken for granted, safety on the job is one of the most important aspects of an ideal work environment. Not adhering to the proper procedures can cause life-altering accidents to happen within a matter of seconds.

From the perspective of an employer, guidelines and legal regulations must be followed in order to protect employees. In this instance, where rules and directions alone are not enough, physical safety measures are needed to avoid work accidents.

ABUS is proud to present its catalogue of Safety and Industrial Products. Products listed are built with the highest quality materials with your safety in mind.



# Lockout/Tagout

Lockout/Tagout procedures are designed to prevent accidents and injuries caused by the unexpected release of energy when equipment is being repaired or maintained.

## Regulations

The Occupational Safety and Health Administration (OSHA) regulates lockout/tagout through the Control of Hazardous Energy Standard found at 29 CFR 1910.147. This standard mandates training, audits and record-keeping to ensure that workers will not be injured by unintentionally energized equipment.

## What is Lockout/Tagout

Lockout is the process of preventing the flow of energy from a power source to a piece of equipment and keeping it from operating.

Lockout is accomplished by installing a lockout device at the power source so that the equipment powered by that source cannot be operated. A lockout device is a lock, block, cable or chain that keeps a switch, valve or lever in the off position. Safety locks are provided and can be used only for lockout purposes. The locks should never be used to lock tool boxes, storage sheds or other items.

Tagout is accomplished by placing a tag on the power source. The tag acts as a warning not to restore energy, not as a physical restraint. Tags must clearly state "Do Not Operate" or the like, and must be applied by hand.

## What Must Be Locked or Tagged Out

The lockout/tagout standard covers servicing and maintenance of equipment where unexpected energization or start-up of equipment could harm employees.



**TIP: Warning stickers warn against risk and dangers!**  
 For the padlocks of the 74 series, ABUS offers proper lockout stickers in different languages. The stickers are useful especially for safety lockout. Through the stickers, it is clear right away that a machine is locked out. Additionally, there is some space on the sticker where the employee can write his or her name.

## Non-Conductive 74 Series

- 6-pin cylinder offers maximum number of key differs and is key-retaining
- Plastic-covered lock body and shackle are non-magnetic and dielectric, providing intrinsically safe protection
- Under the plastic casing, the NANO PROTECT™-coated steel shackle and aluminum or brass lock body are robust and chemical resistant
- Aluminum locks contain 70% recycled materials. All 74 series locks are produced in a facility achieving zero waste to landfill operations at a 98% diversion rate
- Meets OSHA Lockout/Tagout Guidelines
- Comes key-retaining and is available keyed-different, keyed-alike or master-keyed

Item	Shackle Height	# Pins	Shelf Pk Qty	Weight kg	Key Options
74/40	38mm	6	6	0.088	KA, KD, MK, GMK
74/40HB75	75mm	6	6	0.103	KA, KD, MK, GMK
74LB/40	38mm	6	6	0.107	KA, KD, MK, GMK





## Aluminum 72

- Lightweight, anodized aluminum lock body offers superior chemical and corrosion resistance and is ideal for laser engraving
- NANO PROTECT™-coated hardened steel shackle provides superior corrosion resistance and is available in multiple shackle heights
- Meets OSHA lockout/tagout guidelines
- Available keyed-different, keyed-alike or master-keyed



Item	Shackle Height	# Pins	Shelf Pk Qty	Weight kg	Key Options
721B/40	26mm	6	6	0.115	KA, KD, MK, GMK
721B/40HB40	40mm	6	6	0.121	KA, KD, MK, GMK
721B/40HB75	75mm	6	6	0.133	KA, KD, MK, GMK



CORROSION PLATING    DOUBLE BOLTED    KA AVAILABLE    MK AVAILABLE    PARACENTRIC KEYWAY    REKEYABLE    SELF-LOCKING    VALIDATED



Security Tech Germany

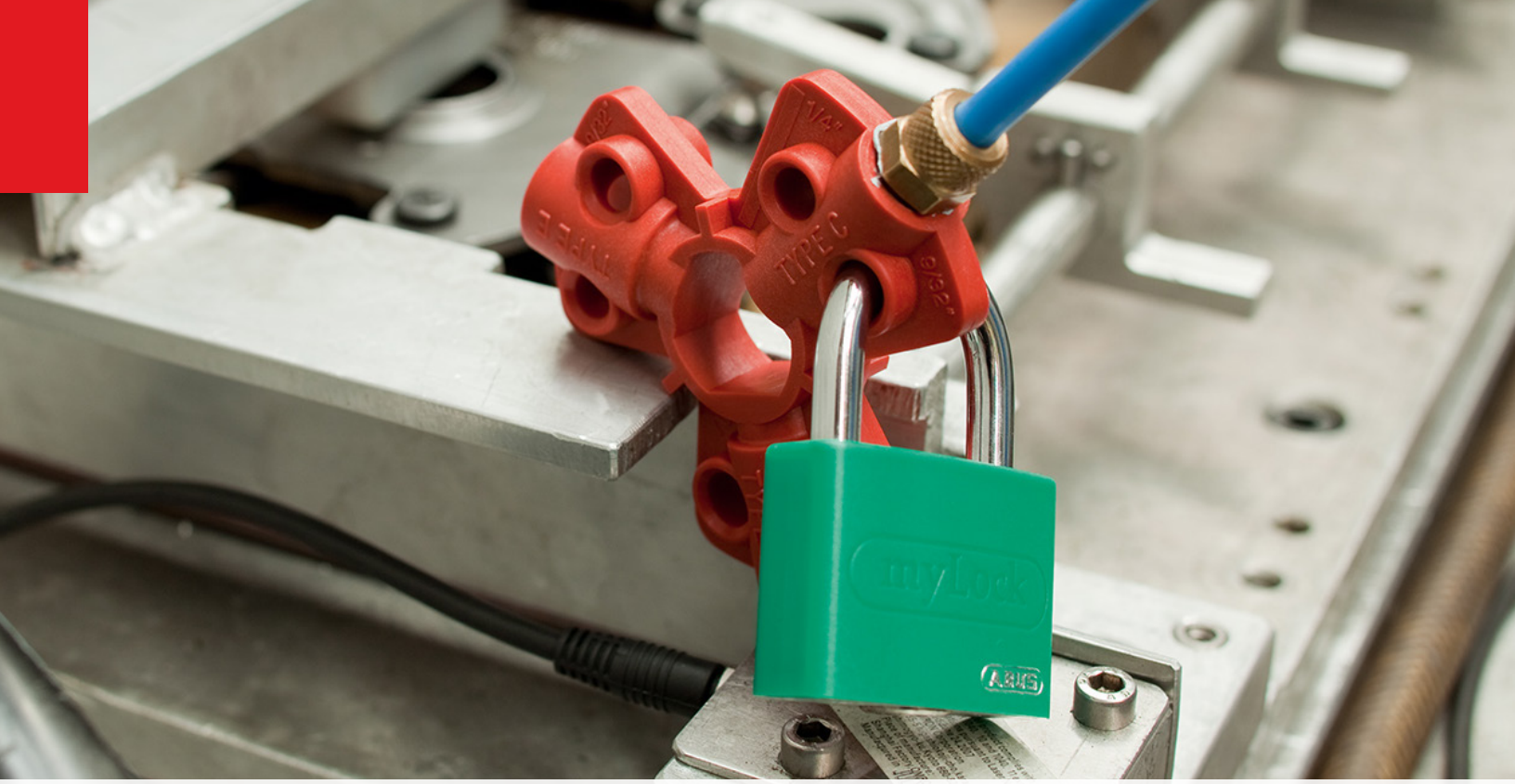

## Aluminium T65AL mylock

- Solid and lightweight aluminium body
- Coloured vinyl casing prevents damage
- Individual inscriptions possible for easy identification
- Shackle made from hardened steel with NANO PROTECT™-coating
- Precision pin cylinder
- Available keyed-different, keyed-alike or master-keyed

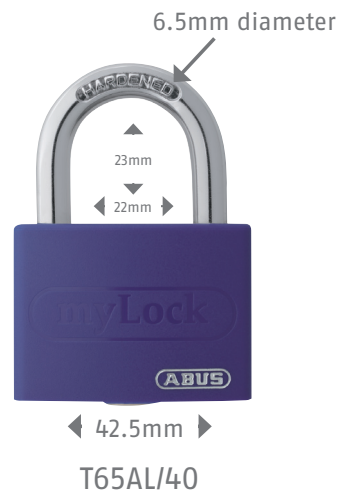

Item	Shackle Height	# Pins	Shelf Pk Qty	Weight kg	Key Options
T65AL/40	23mm	5	12	0.079	KA, KD, MK, GMK
T65AL/40HB40	40mm	5	12	0.100	KA, KD, MK, GMK







## Laminated Steel 41

- 5-pin cylinder offers high number of key differs
- Steel shackle and body plates are individually coated with ETERNATM plating for rust protection
- Vinyl bumper provides easy identification and protection
- Made from high-quality recycled steel
- Tough, countersunk rivets
- Meets OSHA lockout/tagout guidelines
- Available keyed-different, keyed-alike or master-keyed
- FDA-approved lubricant - ideal for the food industry

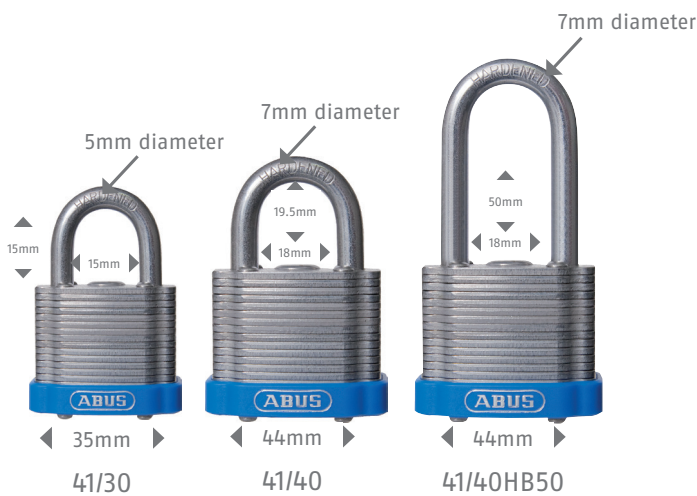

Item	Shackle Height	# Pins	Shelf Pk Qty	Weight kg	Key Options
41/30*	15mm	4 or 5	6	0.130	KA, KD, MK, GMK
41/40	19.5mm	4 or 5	6	0.200	KA, KD, MK, GMK
41/40HB50	50mm	4 or 5	6	0.230	KA, KD, MK, GMK
41/45*	25mm	4 or 5	6	0.280	KA, KD, MK, GMK
41/45HB50*	50mm	4 or 5	6	0.309	KA, KD, MK, GMK
41/50*	25mm	4 or 5	6	0.363	KA, KD, MK, GMK
41/50HB50*	50mm	4 or 5	6	0.402	KA, KD, MK, GMK



\*Available only with blue bumper.



Security Tech Germany



## Non-Sparking Brass T84

- Shackle and body made from solid brass
- Inner components made from non-corrosive materials
- Precision pin tumbler
- Plastic casing available in 6 different colors
- Available keyed-different, keyed-alike or master-keyed



Item	Shackle Height	# Pins	Shelf Pk Qty	Weight kg	Key Options
T84MB/30*	14mm	3	12	0.065	KA, KD, MK, GMK
T84MB/40	21mm	4	12	0.136	KA, KD, MK, GMK
T84MB/50*	24.5mm	5	6	0.192	KA, KD, MK, GMK



\*Available only with black jacket.



## Laser Engraving

ABUS offers custom laser engraving on all Safety Series padlocks. Laser engraving is a great way to customize padlocks in the safety industry, providing quick and easy identification.



Please note: Engraving on bottom of lock is not available.

## Lockout Labels

ABUS carries a variety of lockout labels, available in three languages. Lockout labels can be personalized with a permanent marker, helping to easily identify the owner of each padlock. Customizable colored labels provide easy identification for non-safety padlocks.



## Weatherproof Cap

- Rubberized cap fits on the bottom of 72 Series padlocks
- Durable weather cover with drainage system
- Protects lock cylinder from water, ice, dirt and grime



## High-Security Chain

- Chain made from hardened steel
- Top security against all types of aggressive attacks
- Fabric sleeve prevents surroundings from damage
- Comes in standard 2', 6' and 10' lengths as well as custom chain lengths
- Custom chain lengths come shipped in barrels
- Loop chain comes with a larger loop on one end, making the chain go further

For more info, see page 56.



# Keying Systems

The more machines there are that have to be locked out, the more different keys are needed. But a large number of keys and a confusing key administration are not necessary. Modern keying systems by ABUS are the solution.

A locking system is a combination of different locking cylinders that have a certain relation to each other. Depending on what is needed, the functionalities of the cylinder can be bundled and exactly assigned. Within a locking system there are single keys, master keys and grand master keys – this makes it possible to distribute certain access rights among different employees.



## Keyed Different:

Each padlock has its own unique key.



## Keyed Alike:

Each padlock can be opened with the same key.

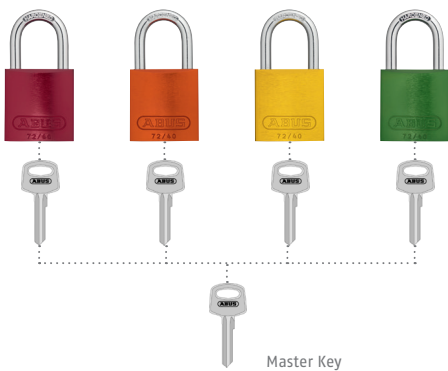

## Keyed Different with Master Key:

Each padlock has its own key. The master key can open all padlocks.

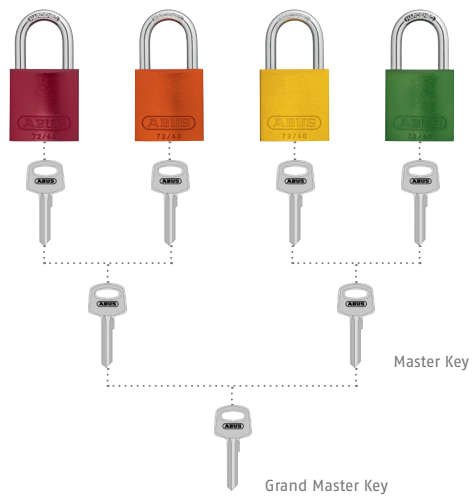

## Keyed Different with Grand Master Key:

Each padlock has its own key. The padlocks of each group can be opened with their respective master key. All padlocks can be opened with the grand master key.



**TIP:** To temporarily block access to switchboards, ABUS offers different varieties of lockout hasps. With these, main power switches and thus energy sources can easily be locked out during maintenance or service work. This is an easy and effective way to avoid accidental restarting of the machine

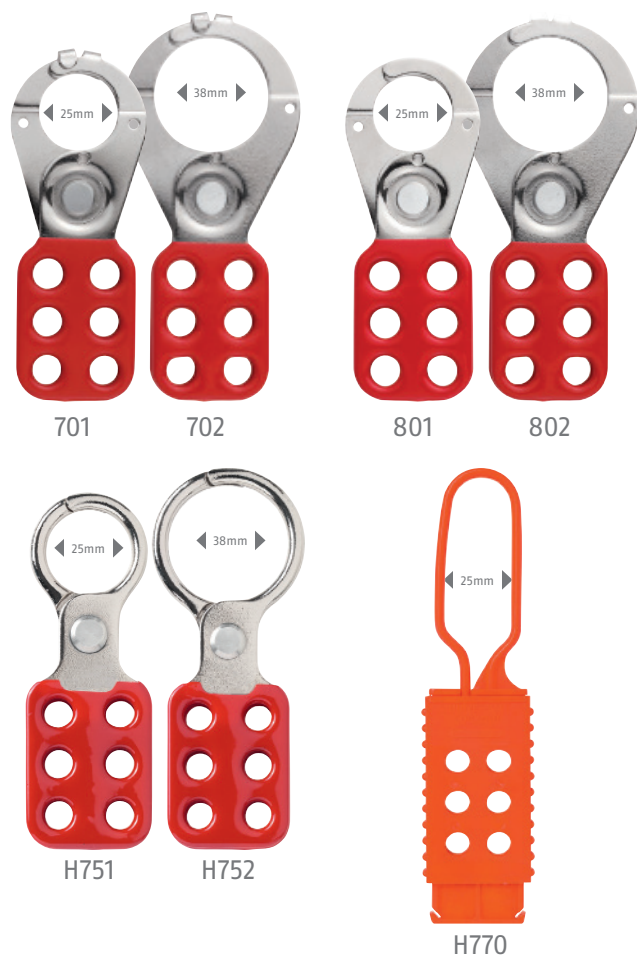

## Lockout/Tagout Hasps

- Holds up to 6 padlocks
- Available with or without pry-resistant interlocking tabs for added security
- High-quality materials for different areas of application: recycled steel, spark-resistant aluminum or non-conductive plastic
- Steel and aluminum: 1" (25mm) or 1/2" (38mm) closed hole available

Item	Opening Diameter	#Lock Holes	Material	Shelf Pk Qty	Weight kg
AU-ABS-701	25mm	6	Recycled Steel	12	0.094
AU-ABS-702	38mm	6	Recycled Steel	12	0.105
AU-ABS-801	25mm	6	Recycled Steel	12	0.101
AU-ABS-802	38mm	6	Recycled Steel	12	0.102
AU-ABS-H751	25mm	6	Aluminium	12	0.040
AU-ABS-H752	38mm	6	Aluminium	12	0.041
AU-ABS-H770	25mm	6	Plastic	12	0.027



## Safety Redbox™

- Safety where you want it, when you need it: portable, convenient lockout box
- High level of stability in spite of low weight
- Ergonomic and space-saving fold-away handle
- Inside is exposed to light from all sides for better visibility of contents
- Lid features innovative and secure locking mechanism
- Patented lockable wall bracket, also facilitates storing of padlocks

Item	Diameter of Holes	#Lock Holes	Material	Shelf Pk Qty	Weight kg
AU-ABS-B835 RED	7mm	12	Recycled Steel	1	1.633



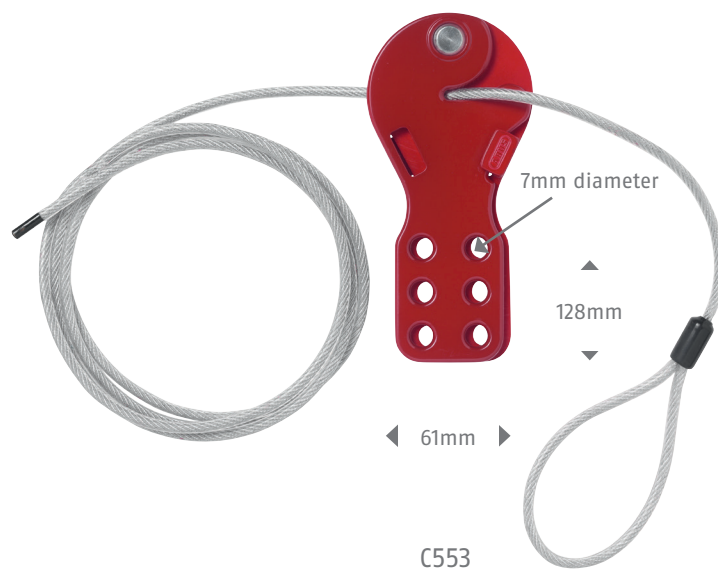
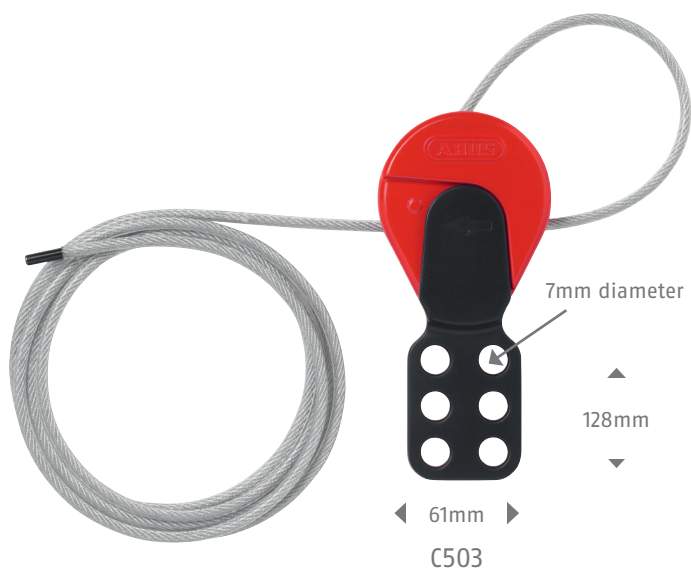

## Safelex™ Universal Cable Lockout

- Intuitive design for self-explanatory application
- Patented grip mechanism for secure fixation of the cable
- Retightening possible at any time, even when locked
- Isolated, exchangeable metal cable in different lengths
- Holds up to 6 padlocks

## Standard Cable Lockout

- Intuitive design for self-explanatory application
- Isolated, exchangeable metal cable in different lengths
- Holds up to 6 padlocks

Item	Cable Length	Cable Diameter	#Lock Holes	Shelf Pk Qty	Shelf Pk kg
AU-ABS-C503	1000mm	4mm	6	12	2.100
AU-ABS-C506	2000mm	4mm	6	12	2.563
AU-ABS-C509	3000mm	4mm	6	12	2.994
AU-ABS-C515	5000mm	4mm	6	10	3.252

Item	Cable Length	Cable Diameter	#Lock Holes	Shelf Pk Qty	Shelf Pk kg
AU-ABS-C553	1000mm	4mm	6	8	1.075
AU-ABS-C556	2000mm	4mm	6	8	1.492
AU-ABS-C559	3000mm	4mm	6	12	2.300
AU-ABS-C565	5000mm	4mm	6	10	2.676

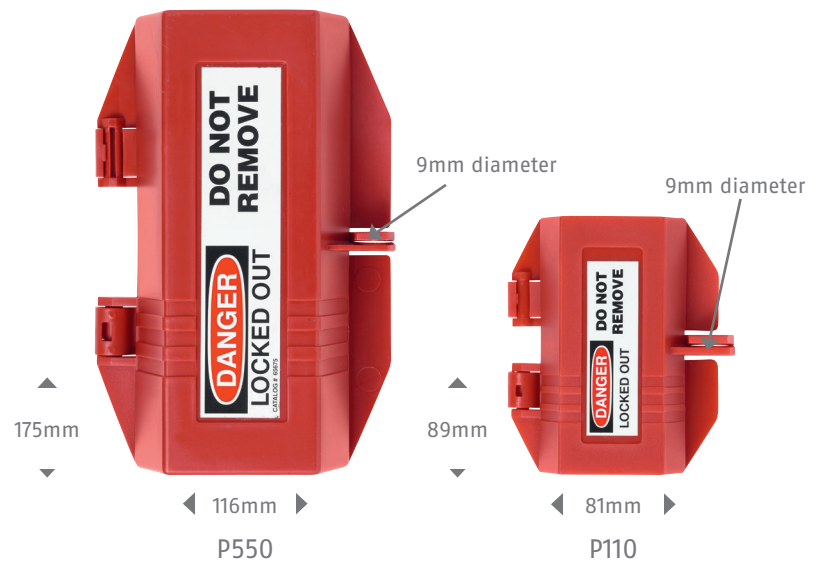

## Switch Lockout

- Made from high-quality polycarbonate housing: long-lasting and robust
- Easy installation: Remove the screws from the wall switch plate and use them to mount the device onto the plate
- Sliding mechanism makes the device very easy to use
- Offers extra durability with hinge-less design
- Holds 1 padlock with up to 8mm (5/16") shackle diameter

Item	#Lock Holes	Shelf Pk Qty	Weight kg
AU-ABS-E250	1	1	0.045

## Power Plug Lockout

- Made from high-quality polypropylene: long-lasting, robust and non-conductive
- 2 Sizes: For standard plugs or high-voltage plugs
- Cable tunnel on both sides to secure plug connections
- Warning stickers in different languages included
- Small version holds up to 2 padlocks; large version holds up to 4 padlocks with a shackle diameter up to 9mm (23/64")

Item	#Lock Holes	Warning Label Languages	Shelf Pk Qty	Weight kg
AU-ABS-P110	2	English, French, Spanish	1	0.068
AU-ABS-P550	4	English, French, Spanish	1	0.213



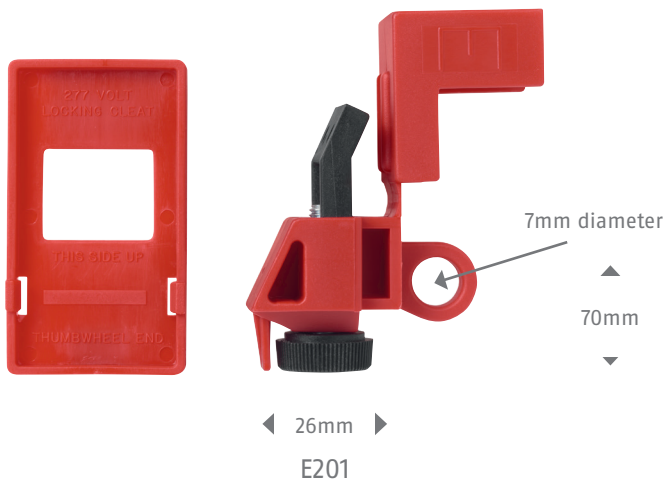

## Single-Pole Breaker Lockout

- Made from high-quality materials: long-lasting, robust and non-conductive
- Easy-to-use with screwing mechanism for secure fixation
- Can be used on common single-pole circuit breakers
- Comes with adapter for blade-type electric fuses
- Holds 1 padlock
- Voltage 120/277

## Multi-Pole Breaker Lockout

- Made from high-quality materials: long-lasting, robust and non-conductive
- Easy-to-use with screwing mechanism for secure fixation
- Holds up to 2 padlocks with a shackle diameter up to 7mm (9/32")
- Can be used on common multi-pole circuit breakers that employ a tie bar
- Voltage 120/277

Item	#Lock Holes	Max. Width of Circuit Breaker	Shelf Pk Qty	Weight kg
AU-ABS-E201	1	16mm	1	0.0318

Item	#Lock Holes	Max. Thickness of Bond Bridge	Shelf Pk Qty	Weight kg
AU-ABS-E202	2	9mm	1	0.0318

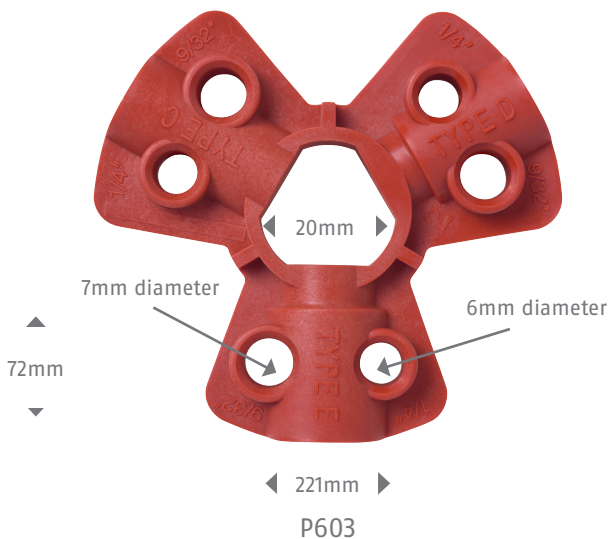

## Compressed Air Lockout

- Made from fiber-glass reinforced nylon: long-lasting, robust and non-conductive
- 3 different connections for most common compressed air couplings with 15mm outside diameter
- The hole in the middle can be used to attach and store the lockout device directly at the connection
- Holds 1 padlock with 6mm and 1 padlock with 7mm shackle diameter per connection

Item	#Lock Holes	Shelf Pk Qty	Weight kg
AU-ABS-P603	6	1	0.045

## Gas Cylinder Lockout

- Made from high-quality polypropylene: long-lasting, robust and non-conductive
- Warning sticker included
- Holds 1 padlock with up to 9mm shackle diameter

Item	#Lock Holes	Inside Height	Inside Diameter	Shelf Pk Qty	Weight kg
AU-ABS-P606	1	139mm	78mm	1	0.141

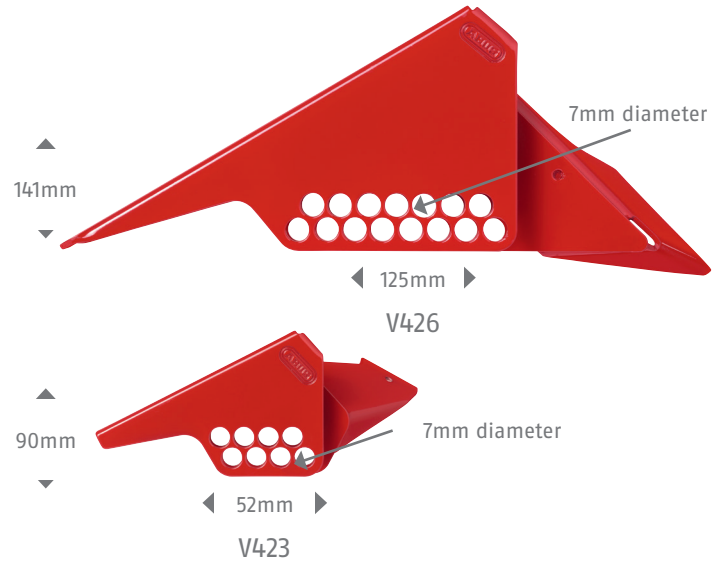
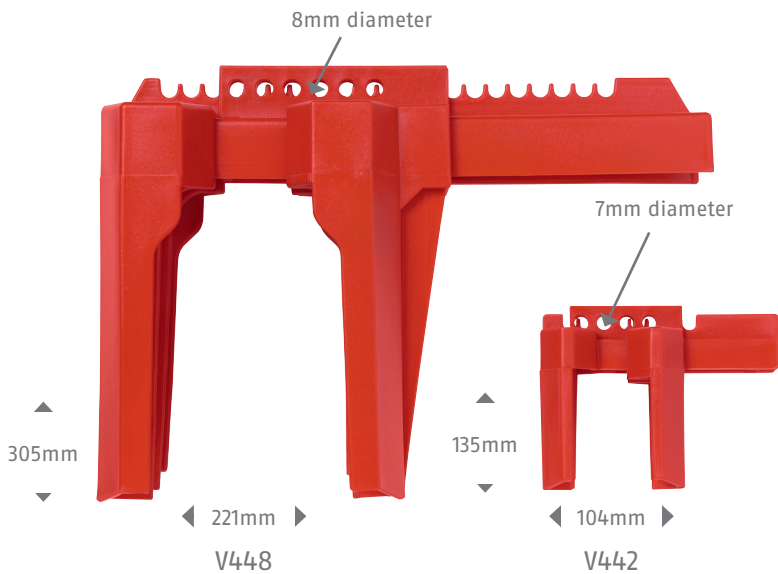

## Plastic Ball Valve Lockout

- Made from high-quality polypropylene; long-lasting and non-conductive
- Two sizes: Fits ball valves from 13mm (1/2") to 203mm (8")
- Well-positioned padlock holes for better grip on the valve
- Small holds up to 4 padlocks; large holds up to 6 padlocks

Item	#Lock Holes	Max Handle Thickness	Max Handle Width	Shelf Pk Qty	Weight kg
AU-ABS-V442	4	10mm	23mm	1	0.154
AU-ABS-V448	6	24mm	43mm	1	0.653

## Metal Ball Valve Lockout

- Stable and secure, made from powder-coated steel
- Two sizes for most common ball valves
- Various holes for exact positioning of padlock gives stability
- Best used on hard-to-reach pipes
- Holds 1 padlock with up to 7mm (9/32") shackle diameter

Item	#Lock Holes	Max Handle Thickness	Max Handle Width	Shelf Pk Qty	Weight kg
AU-ABS-V423	1	7mm	37mm	1	0.091
AU-ABS-V426	1	10mm	50mm	1	0.340



## Gate Valve Lockout

- Made from high-quality polypropylene: long-lasting and non-conductive
- Five sizes: Fits gate valves from 25mm (1") to 330mm (13")
- Holds 1 padlock with up to 9mm (23/64") shackle diameter
- Predetermined breaking point at the top for threaded valves
- Stickers in various languages included

Item	#Lock Holes	Fits Gate Valve Size	Shelf Pk Qty	Weight kg
AU-ABS-V303	1	25 - 63.5mm	1	0.0363
AU-ABS-V305	1	63.5 - 127mm	1	0.181
AU-ABS-V307	1	127 - 165mm	1	0.290
AU-ABS-V310	1	165 - 254mm	1	0.621
AU-ABS-V313	1	254 - 330mm	1	1.012

## Lockout Tags

- Prevent accidental or unexpected start-up or release of stored energy when working on equipment or machinery
- Unrippable vinyl with grommet and matte surface to withstand moisture
  - Available tag types: DO NOT OPERATE; OUT OF SERVICE; DO NOT OPERATE with photo ID; EQUIPMENT LOCKED OUT with photo ID
- Recycled plastic, high quality
  - Available tag types: DO NOT OPERATE; OUT OF SERVICE

Item	Tag Material	Tag Text	Shelf Pk Qty	Shelf Pk kg
AU-ABS-T100	Unrippable Vinyl	DO NOT OPERATE	10	0.068
AU-ABS-T102	Unrippable Vinyl	OUT OF SERVICE	10	0.068
AU-ABS-T104	Unrippable Vinyl	DO NOT OPERATE - Photo ID	10	0.068
AU-ABS-T106	Unrippable Vinyl	OUT OF SERVICE - Photo ID	10	0.068
AU-ABS-T200	Recycled Plastic	DO NOT OPERATE	10	0.118
AU-ABS-T202	Recycled Plastic	OUT OF SERVICE	10	0.118



**NOTE:** Toolboxes are made from 100% recycled polypropylene. Bags are made from heavy strength, recycled PET fabric with double sewn seams that is water repellent and fire retardant with a PVC-free coating.



### Small Pouch Personal Kit

- Includes:
  - (2) 74/40 Padlocks, (1) 25mm Hasp, (1) 38mm Hasp,
  - (1) Breaker Lockout, (3) Tags, (3) Ties, (1) Small Pouch

### Large Pouch Valve Kit

- Includes:
  - (2) 74/40 Padlocks, (1) 25mm Hasp, (1) 38mm Hasp,
  - (1) Breaker Lockout, (1) 25mm - 63mm Valve Cover,
  - (1) 63mm - 127mm Valve Cover, (3) Tags, (3) Ties,
  - (1) Large Pouch

Item	Bag Width	Bag Height	Bag Depth	Shelf Pk Qty	Weight kg
AU-ABS-K900	165mm	127mm	45mm	1	0.526

Item	Bag Width	Bag Height	Bag Depth	Shelf Pk Qty	Weight kg
AU-ABS-K905	178mm	216mm	76mm	1	0.771





## Large Pouch Personal Kit

- Includes:
  - (2) 74/40 Padlocks, (1) 25mm Hasp, (1) 38mm Hasp,
  - (1) Large Plug Lockout, (1) Small Plug Lockout,
  - (3) Tags, (3) Ties, (1) Large Pouch

## Lockout Bag Kit

- Includes:
  - (2) 74/40 Padlocks, (2) 74HB/40 Padlocks, (2) 25mm Hasp,
  - (2) 38mm Hasp, (3) Breaker Lockouts, (1) Wall Switch Lockout,
  - (1) 63mm - 127mm Gate Valve Lockout, (1) Large Plug Lockout,
  - (1) Small Plug Lockout, (10) Tags, (10) Ties, (1) Lockout Bag

Item	Bag Width	Bag Height	Bag Depth	Shelf Pk Qty	Weight kg
AU-ABS-K910	178mm	216mm	76mm	1	0.803

Item	Bag Width	Bag Height	Bag Depth	Shelf Pk Qty	Weight kg
AU-ABS-K915	457mm	254mm	152mm	1	1.733



## Lockout Belt Kit

- Includes:
  - (2) 74/40 Padlocks, (2) 25mm Hasp, (1) Breaker Lockout,
  - (1) Small Plug Lockout, (1) 63mm - 127mm Gate Valve Lockout,
  - (5) Tags, (5) Ties, (1) Belt Pouch

## Lockout Toolbox

- Includes:
  - (3) 74/40 Padlocks, (3) 25mm Hasps, (3) Breaker Lockouts,
  - (1) Large Plug Lockout, (1) Small Plug Lockout,
  - (1) 25mm - 63mm Gate Valve Lockout, (10) Tags, (10) Ties,
  - (1) Lockout Toolbox

Item	Bag Width	Bag Height	Shelf Pk Qty	Weight kg
AU-ABS-K920	610mm	152mm	1	0.934

Item	Box Width	Box Height	Box Depth	Shelf Pk Qty	Weight kg
AU-ABS-K925	330mm	165mm	127mm	1	1.483



## Electrical, Valve Toolbox

- Includes:
  - (3) 74/40 Padlocks, (1) 1" Hasp, (1) Breaker Lockout, (1) 25mm-63mm Gate Valve Lockout, (1) 63mm-127mm Gate Valve Lockout, (1) Safelex™ Cable Lockout, (2) Small Ball Valve Lockouts, (1) Wall Switch Lockout, (12) Tags, (12) Ties, (1) Lockout Toolbox

Item	Box Width	Box Height	Box Depth	Shelf Pk Qty	Weight kg
AU-ABS-K930	330mm	165mm	127mm	1	1.284



## Valve Lockout Toolbox

- Includes:
  - (2) 74/40 Padlocks, (1) 63mm-127mm Gate Valve Lockout, (1) Safelex™ Cable Lockout, (2) Small Ball Valve Lockouts, (10) Tags, (10) Ties, (1) Lockout Toolbox

Item	Box Width	Box Height	Box Depth	Shelf Pk Qty	Weight kg
AU-ABS-K940	330mm	165mm	127mm	1	1.139



## Combination Toolbox

- Includes:
  - (2) 74/40 Padlocks, (1) Breaker Lockout, (1) 63mm-127mm Gate Valve Lockout, (1) Small Ball Valve Lockout, (1) Wall Switch Lockout, (1) Small Plug Lockout, (10) Tags, (10) Ties, (1) Lockout Toolbox

Item	Box Width	Box Height	Box Depth	Shelf Pk Qty	Weight kg
AU-ABS-K935	330mm	165mm	127mm	1	1.343



## Operator Lockout Toolbox

- Includes:
  - (1) 74/40 Padlock (1) 25mm Hasp (1) Breaker Lockout (1) Tag, (1) Tie, (1) Lockout Toolbox

Item	Box Width	Box Height	Box Depth	Shelf Pk Qty	Weight kg
AU-ABS-K945	330mm	165mm	127mm	1	0.599



## Lockout Stations

- Lockout/Tagout Stations centralize LOTO activity
- Available in different sizes
- Portable and wall-mounted
- Designed with durability for industrial settings
- Each hook can hold 2 padlocks or 2 hasps

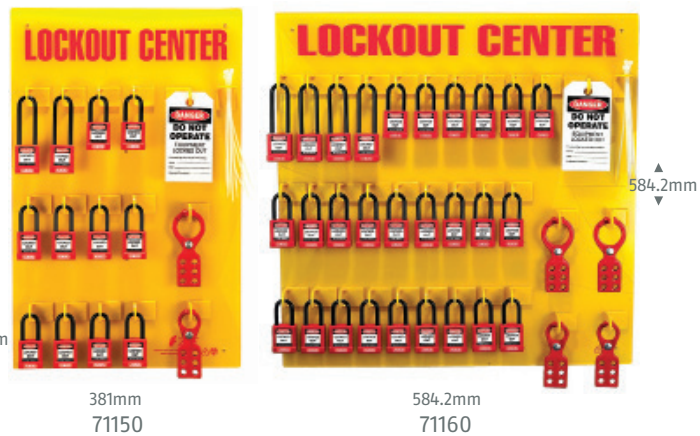
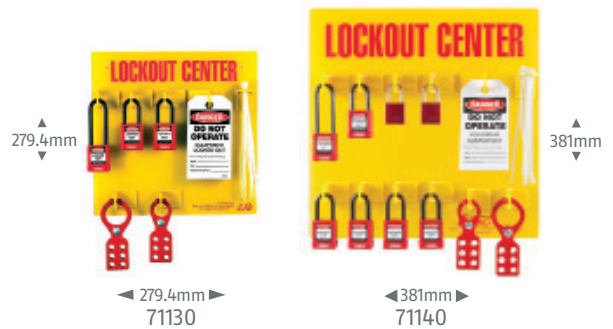

Item	Board Width	Board Height	Hold # Locks	Holds # Hasps	Shelf Pk Qty	Weight kg
AU-ABS-71130	279.4mm	279.4mm	3	2	1	2.155
AU-ABS-71140	381mm	381mm	8	2	1	2.948
AU-ABS-71150	381mm	584.2mm	12	2	1	3.062
AU-ABS-71160	584.2mm	584.2mm	28	4	1	8.391



# 83 Series® 2

## The Locksmith's Padlock of Choice



### Features

#### KnK Cylinder Compatibility

Most OEM KnK cylinder assemblies will fit into the new 83 Series® 2 padlocks. The use of special adapters is required. KnK Adapter Kit Includes: Bible Cover, Schlage® & Primus®, Medeco®, Mul-T-Lock®, Ilco®/Sargent KnK Drivers.



KnK Adapter Kit

#### Shackle Changing Tools

There are two new shackle changing tools for use with ABUS 83 Series® 2. Version 1 is a solid aluminum, steel tip tool designed for use in the workshop environment. Version 2 is an economy version of this tool, designed for use in a van or onsite and when only a smaller number of shackles needs to be changed. A flat bladed screwdriver can no longer be used to remove the shackle, reducing the likelihood of a consumer accidentally doing so.



Professional Aluminum Shackle Change Tool

#### Easy Shackle Change Feature

The popular "Easy Shackle Change" feature has been expanded to all 83ALs, 83/45, 83KnK/45, 83/50, 83MAR/45, 83WPIB/53, 83WP/53 and most IC padlocks.

#### Shackle Collar and Chain

With an ABUS shackle collar and chain, you can affix any one of our 83 Series® 2 padlocks to a specific location to help prevent loss and contamination of the padlock. The shackle collar slides up the leg of the shackle and holds the chain attached to the padlock when open. Shackle collars are available for 5/16", 3/8" and 7/16" diameter shackles and can be purchased individually or in a collar kit which includes 6 collars of each size.



Shackle Collar

#### 3-in-1 Bolt Driver

The 3-in-1 bolt driver setup has been retained for the large steel-bodied padlocks. Changing shackles becomes much simpler using this tools as the spring does not need to be reset. The 3-in-1 bolt driver is used in the 83/55, 83CS/55, 83/80 and 83WP/63 Series 2 as well as all IC padlocks.



3-in-1 Bolt Driver

#### Symmetrical Z-Bar

A new 83 Series® 2 Z-bar has been designed for use in converting from key-retaining to non-key-retaining in seconds. It looks similar to the existing Z-bar, but is symmetrical and has a black dot printed on it, distinguishing it from the old Z-bar which is produced with a red dot. The old S1 Z-bar is shaped differently than the new S2 Z-bar, therefore the two are not interchangeable.



S2 Z-Bar

#### 83 S2 Service Kit

ABUS 83 Series® 2 Service Kit is the perfect way to keep all your parts for the 83 Series organized in your shop or in your van. The kit includes a variety of shackles for the 83/45, cylinders, KnK bible covers and adapters, Z-bars, Easy Shackle Change Tools and much more.



83 S2 Service Kit

#### Cylinder Cover

A rubberized weatherproof cylinder cover is available for select 83 Series® 2 padlocks. The cover fits snugly on the bottom of the lock and protects the cylinder from precipitation and debris.



Cylinder Cover

### Keyways



100 YALE No. 8	200 Kwikset 5-Pin	300 & 306 Schlage C	EVER Schlage EVER	400 Corbin 60 59A1 59A2 5981 5982	410 Corbin L4	700 Sargent L4-LC	800 Weiser Falcon	888 ABUS	900 Arrow	1000 Russwin D1-D4	3000 Schlage C-L
----------------------	-------------------------	---------------------------	-------------------------	--	---------------------	-------------------------	-------------------------	-------------	--------------	--------------------------	------------------------

Schlage C 300 is 6-5 pin loaded and Schlage C 306 is 6-6 pin loaded  
Schlage Everest EVER is a composite that will fit all Everest C keyways





## Professional TITALIUM™ 83

- Solid lock body made of TITALIUM™ aluminum alloy
- Shackle made of hardened steel with NANO PROTECT™ coating for extra corrosion resistance
- Patented "Z-bar" converts key-retaining to non-key-retaining and vice versa within seconds
- Patented "Pinning Window" for simple rekeying
- Can be keyed into many popular keyways
- Shackle can be changed in seconds
- Weather-proof cap available upon request

Item	Shackle Height (mm)	# Pins	Shelf Pk Qty	Weight kg
83AL/40	25, 38, 75, 100	5-6	6	0.179
83AL/45	25, 50, 75, 100, 150	5-6	6	0.204
83AL-IC/40	25, 38, 75, 100	-	6	0.103



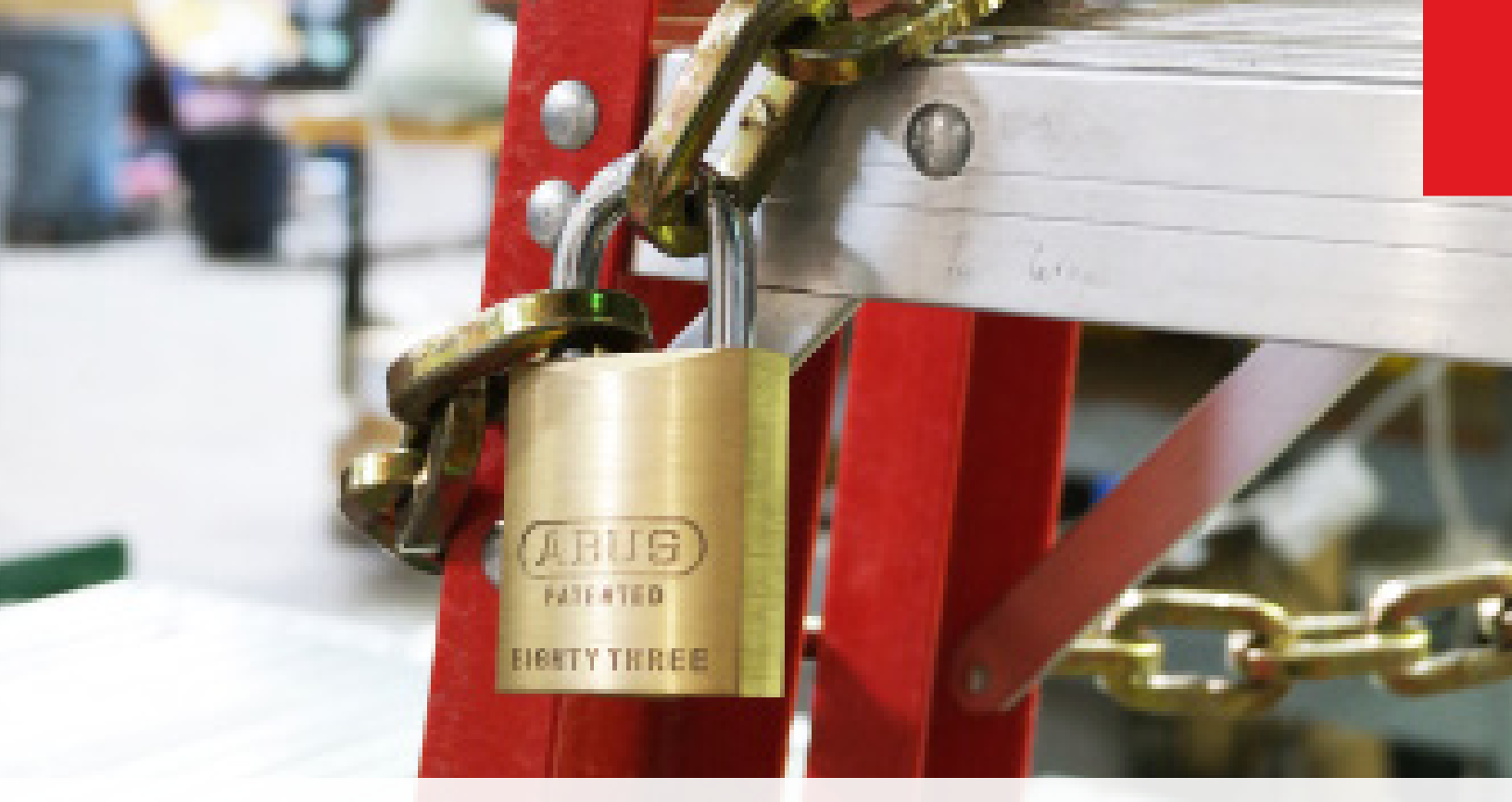

## Professional Brass 83

- Body made of solid brass
- Shackle made of hardened steel with NANO PROTECT™ coating for extra corrosion resistance
- Patented "Z-bar" converts key-retaining to non-key-retaining and vice versa within seconds
- Patented "Pinning Window" for simple rekeying
- Can be keyed into many popular keyways
- Shackle can be changed in seconds
- Cylinder cover available upon request



Item	Shackle Height (mm)	# Pins	Shelf Pk Qty	Weight kg
83/40	25, 38, 75, 100	5-6	6	0.286
83/45	25, 50, 75, 100, 150	5-6	6	0.338
83CS/45	25, 50, 75, 100, 150	5-6	6	0.379
83IC/45	25, 50, 75, 100, 150	-	6	0.270
83KnK/45	25, 50, 75, 100, 150	-	6	0.254



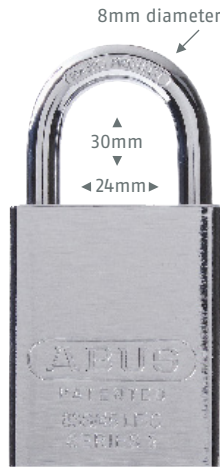

83S/45 LFIC



83/50



83CS/50

## Hardened Steel LFIC 83

- Body made from hardened steel with NANO PROTECT™ coating - same superior corrosion resistance as 83WP
- Hardened steel shackle with NANO PROTECT™ coating, available in different heights
- Padlock can be ordered without shackle to customize lock
- Accepts LFIC Schlage® cylinders
- Accepts all 83WP/53 compatible shackles
- Shackle can be changed in seconds

Item	Shackle Height (mm)	# Pins	Shelf Pk Qty	Case Pk Lbs
83S/45 LFIC	30, 65, 75, 100	-	5-6	0.282

## Professional Chrome-Plated 83

- Body made of chrome-plated solid brass
- Shackle made of hardened steel with NANO PROTECT™ coating for extra corrosion resistance
- Patented "Z-bar" converts key-retaining to non-key-retaining and vice versa within seconds
- Patented "Pinning Window" for simple rekeying
- Can be keyed into many popular keyways
- Shackle can be changed in seconds

Item	Shackle Height (mm)	# Pins	Shelf Pk Qty	Weight kg
83/50	27, 50, 75, 100	5-6	6	0.360
83CS/50	28, 50, 75, 100	5-6	6	0.402
83IC/50	25, 50, 75, 100	-	6	0.292
83KnK/50	25, 50, 75, 100	-	6	0.292
83CS-KnK/50	25, 50, 75, 100	-	6	0.333



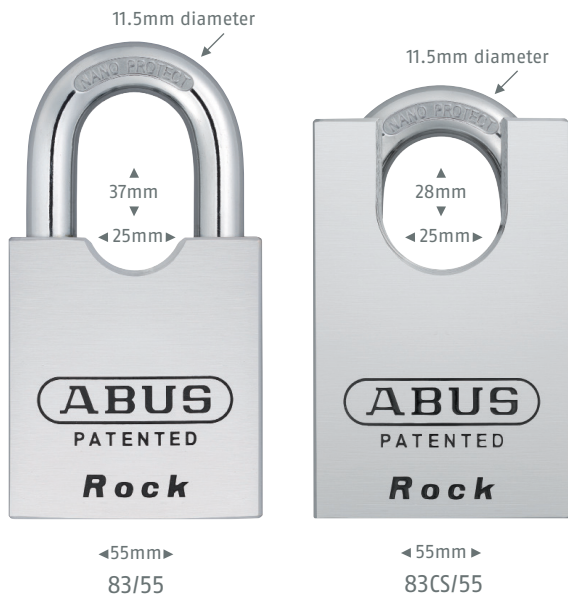

## Professional Steel Rock 83

- Body and shackle made from hardened steel, chrome-plated with NANO PROTECT™ coating for an extreme corrosion resistance
- Patented "Z-Bar" converts key-retaining to non-key-retaining and vice versa within seconds
- RK: cylinder can be re-keyed to match an existing key
- CS: shackle guard protects shackle from attack
- Cylinder cover available upon request

Item	Shackle Height (mm)	Pins in Cylinder	Shelf Pk Qty	Weight kg
83/55	25, 36.5, 75	5-6	6	0.594
83CS/55	25, 36.5, 75	5-6	6	0.675
83KnK/55	25, 36.5, 75	-	6	0.534
83CS-IC/55	25, 36.5, 75	-	6	0.572
83CS-KnK/55	25, 36.5, 75	-	6	0.576



## Professional Steel Rock 83

- Can be adapted to meet various requirements within seconds - no special tools needed
- Body and shackle made from hardened steel, chrome-plated with NANO PROTECT™ coating for an extreme corrosion resistance
- Double bolted
- Patented "Z-Bar" converts key-retaining to non-key-retaining and vice versa within seconds
- Cylinder cover available upon request

Item	Shackle Height (mm)	Pins in Cylinder	Shelf Pk Qty	Weight kg
83/80	43	5-6	6	1.420



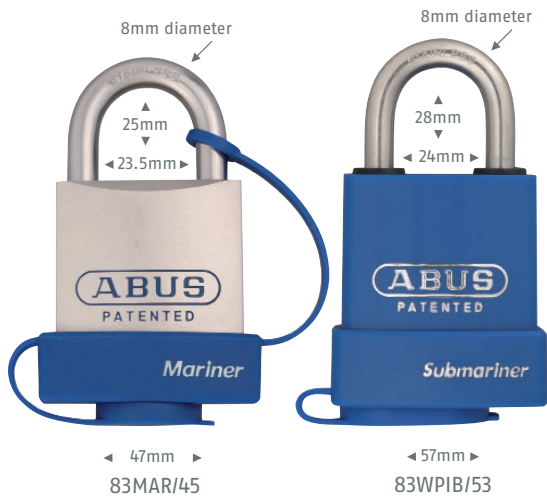
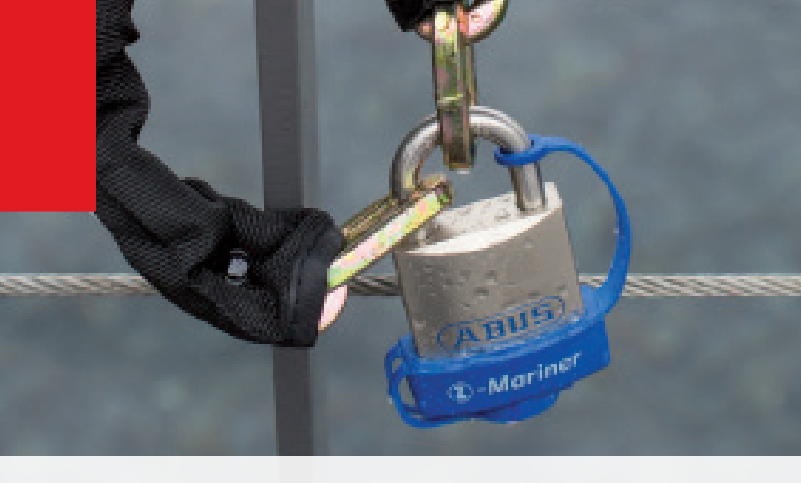

## Professional Weatherproof 83

- Brass body with extra plating for perfect corrosion resistance
- Shackle made of stainless steel
- Durable weather cover with drainage system
- Patented "Z-bar" converts key-retaining to non-key-retaining and vice versa within seconds
- Patented "Pinning Window" for simple rekeying
- Can be keyed into many popular keyways
- Shackle can be changed in seconds

Item	Shackle Height (mm)	# Pins	Shelf Pk Qty	Weight kg
83MAR/45	25, 50, 75, 100	6	6	0.345
83WP/53	29	6	6	0.342



## Professional Weatherproof 83

- Shackle and body made of hardened steel with NANO PROTECT™ coating for extra corrosion resistance
- RK: cylinder can be re-keyed to match an existing key
- Patented "Z-Bar" converts key retaining to non-key retaining and vice versa in seconds
- Patented "Pinning Window" for simple rekeying
- Durable weather cover with drainage system
- 83WP/53: shackle can be changed in seconds

Item	Shackle Height (mm)	# Pins	Shelf Pk Qty	Weight kg
83WP/53	27, 65, 75, 100	6	6	0.371
83WP-IC/53	27, 65, 75, 100	6	6	0.303
83WP-KnK/53	27, 65, 75, 100	6	6	0.303
83WP-LFIC/53	27, 65, 75, 100	-	6	0.303
83WP/53	24.5	-	6	0.420
83WP/63	35, 65	6	6	0.526
83WP-IC/63	35, 65	-	6	0.424
83WP-KnK/63	35, 65	6	6	0.424



# Interchangeable Core Padlocks

## Features

- Accepts 6-pin and 7-pin SFIC cylinders
- Available in solid aluminum, solid brass, solid brass chrome-plated and solid hardened steel bodied padlocks
- Double-ball shackle locking
- Hardened steel shackle with NANO PROTECT™ coating for extreme corrosion resistance
- 3-in-1 bolt driver makes it easy to change shackles as the spring does not need to be reset
- Patented "Z-bar" allows padlock to be easily converted from non-key-retaining to key-retaining in seconds
- Shackles available in a choice of materials - hardened steel shackle with NANO PROTECT™ coating for extreme corrosion resistance, stainless steel and brass
- Shackles available in a range of lengths from 25mm to 150mm
- New! Exchange shackles in seconds with the easy shackle change tool (not available on 83AL-IC/40, 83CS-IC/55 or 83WP-IC/63)
- 83WP-LFIC/53 and 83S/45 LFIC accept LFIC Schlage® cylinders

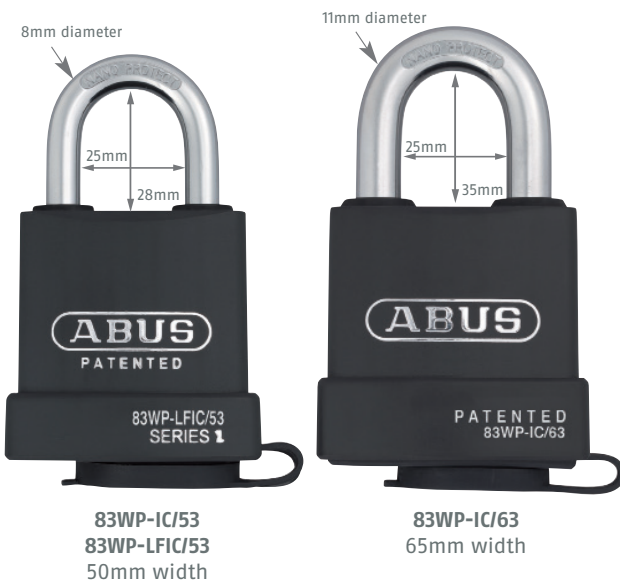
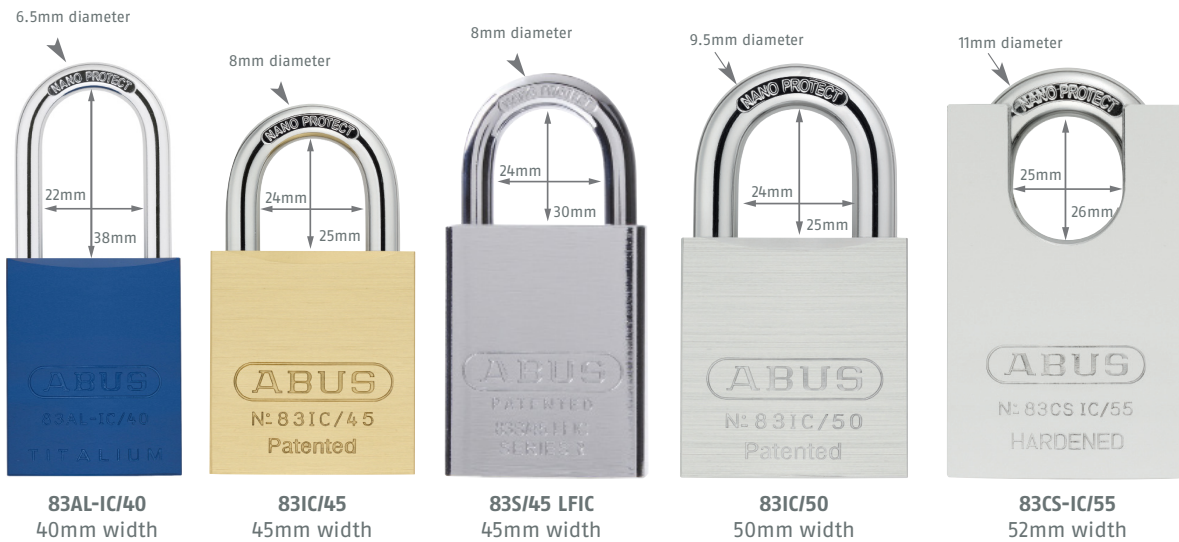

## All Drivers Included



Item	Shackle Height (mm)	Shelf Pk Qty	Weight kg
83AL-IC/40	25, 40, 75, 100	6	1.50
83IC/45	25, 50, 75, 100, 150	6	3.85
83S/45 LFIC	30, 65, 75, 100	6	3.88
83IC/50	25, 50, 75, 100	6	4.13
83CS-IC/55	25, 28, 75	6	7.56
83WP-IC/53	27, 65, 75, 100	6	5.10
83WP-LFIC/53	27, 65, 75, 100	6	4.38
83WP-IC/63	35, 65	6	5.50

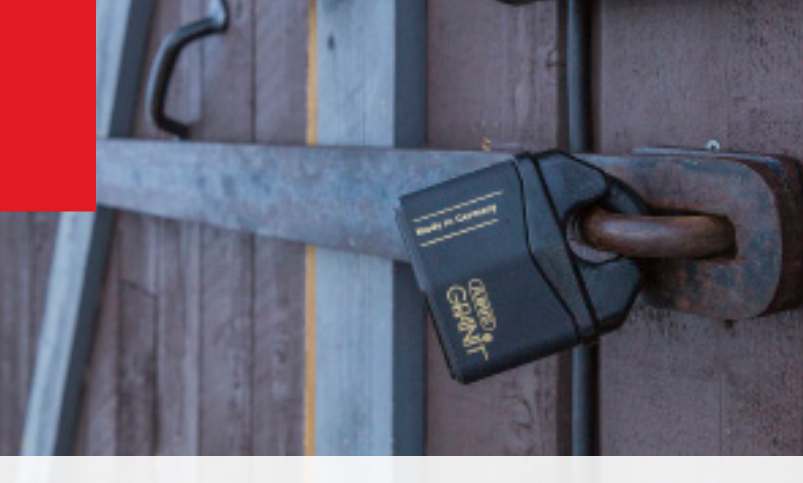

## Granit™ 37RK/80

- Body and shackle made from hardened alloy steel
- ABUS-Plus disk cylinder, highest protection against manipulation, high number of key differs
- Cylinder inserted from the top: optimum drill and pull resistance
- Black Granit™ coating for high corrosion resistance
- Cylinder can be rekeyed to match an existing key
- Shackle guard protects against attacks with tools
- 2 keys, 1 with LED light

Item	Shackle Height	# Pins	Key Options	Shelf Pk Qty	Weight kg
37RK/80		7	KD, KA, MK	1	1.022

## Granit™ 37RK/70

- Body and shackle made from hardened alloy steel
- ABUS-Plus disk cylinder, highest protection against manipulation, high number of key differs
- Cylinder inserted from the top: optimum drill and pull resistance
- Black Granit™ coating for high corrosion resistance
- Cylinder can be rekeyed to match an existing key
- 2 keys, 1 with LED light

Item	Shackle Height	# Pins	Key Options	Shelf Pk Qty	Weight kg
37RK/70	35mm	7	KD, KA, MK	1	0.863







## Granit™ 37RK/60, 37/60

- Body and shackle made from hardened alloy steel
- ABUS-Plus disk cylinder, highest protection against manipulation, high number of key differs
- Shackle guard protects shackle from attacks
- Black Granit™ coating for high corrosion resistance
- Cylinder can be rekeyed to match an existing key
- 2 keys, 1 with LED light

Item	Shackle Height	# Pins	Key Options	Shelf Pk Qty	Weight kg
37RK/60	16mm	7	KD	1	0.580
37/60	16mm	7	KD	1	0.580



## Granit™ 37RK/55, 37/55

- Shackle and body made from hardened alloy steel
- ABUS-Plus disk cylinder, highest protection against manipulation, high number of key differs
- Black Granit™ coating for high corrosion resistance
- Cylinder can be rekeyed to match an existing key
- 2 keys, 1 with LED light

Item	Shackle Height	# Pins	Key Options	Shelf Pk Qty	Weight kg
37RK/55	26.5mm	7	KD, KA, MK	3	0.445
37/55	26.5mm	7	KD	1	0.445
37/55HB50	50mm	7	KD, KA, MK	3	0.510
37/55HB75	75mm	7	KD, KA, MK	4	0.553





## Granit™ 37ST/55

- Body and shackle made of stainless steel for extreme rust protection
- ABUS-Plus disk cylinder, highest protection against manipulation, high number of key differs
- Special ball locking mechanism for exceptional pull resistance
- Anti-drill plate making drilling out the cylinder impossible
- 2 keys, 1 with LED light

Item	Shackle Height	# Pins	Key Options	Shelf Pk Qty	Weight kg
37ST/55	26mm	7	KD	1	0.460



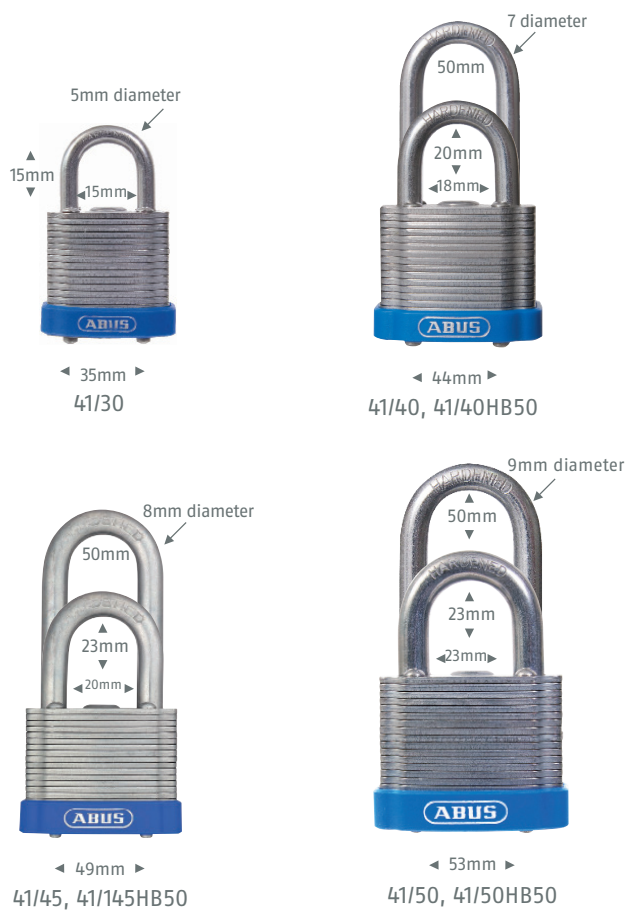
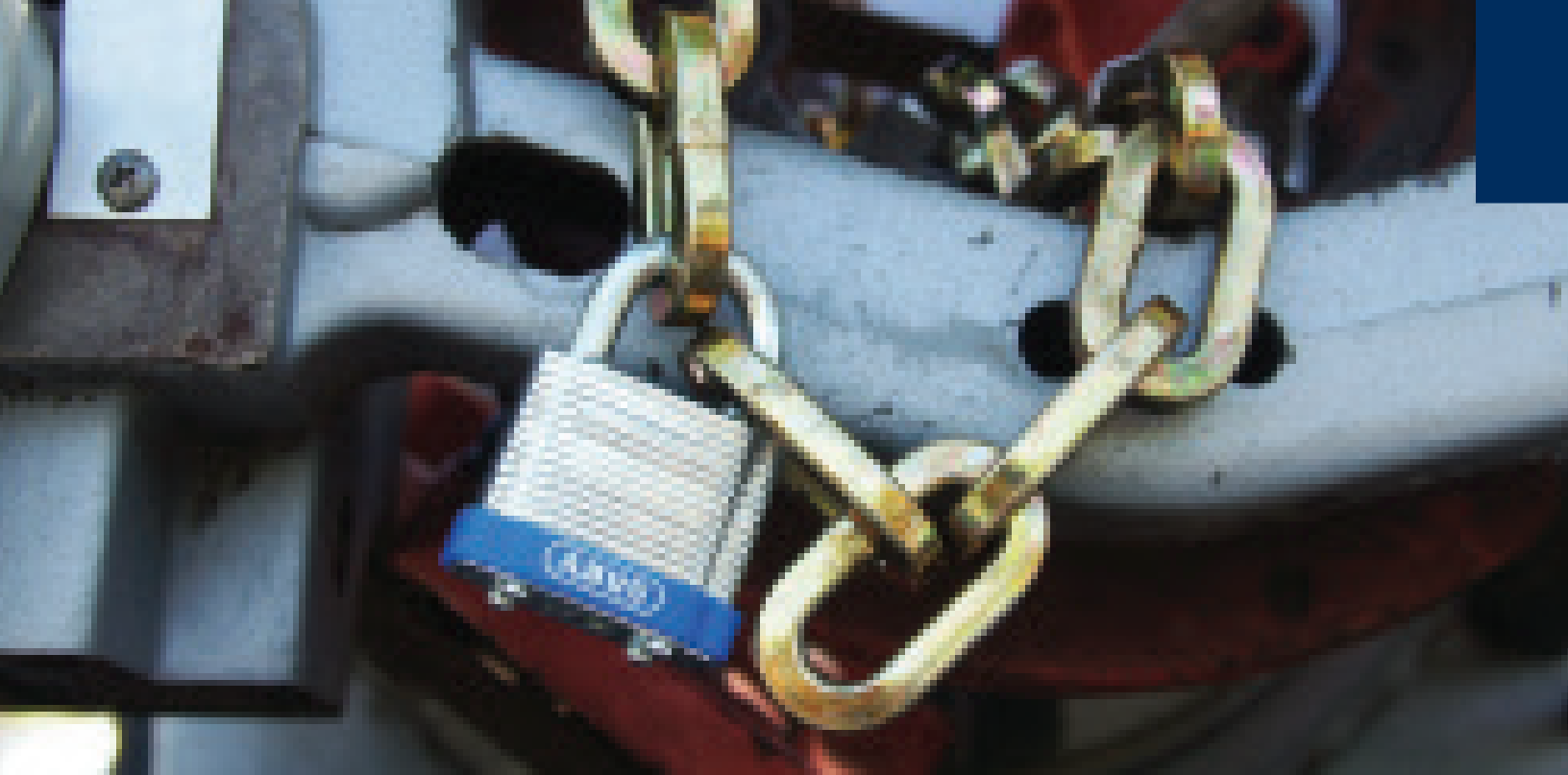

## Laminated Steel 41 - Industrial Grade

- Laminated steel with ETERNA™ coating on each laminate for extreme corrosion resistance
- ETERNA™: Non-hazardous, cadmium-free plating
- Tough, countersunk rivets
- Hardened steel shackle
- High-precision 5-pin tumbler, drilling and pulling protected
- Cylinder available in 2 versions: RH 5-pin cylinder & Master M1 4-pin cylinder
- Cylinder drilling and pulling protection
- Coloured plastic bumper for easy identification (8 colours)

Item	Shackle Height	# Pins	Shelf Pk Qty	Weight kg	Key Options
41/30	15mm	4 or 5	12	0.130	KA, KD, MK, GMK
41/30HB50	50mm	4 or 5	12	0.133	KA, KD, MK, GMK
41/40	19.5mm	4 or 5	12	0.200	KA, KD, MK, GMK
41/40HB50	50mm	4 or 5	6	0.230	KA, KD, MK, GMK
41/45	23mm	4 or 5	6	0.280	KA, KD, MK, GMK
41/45HB50	50mm	4 or 5	6	0.309	KA, KD, MK, GMK
41/50	25mm	4 or 5	6	0.363	KA, KD, MK, GMK
41/50HB50	50mm	4 or 5	6	0.402	KA, KD, MK, GMK
41/50HB125	125mm	4 or 5	6	0.450	KA, KD, MK, GMK





## High Security Diskus® 20

- Original Diskus® design: 360° protection
- 100% non-corrosive stainless steel inside and out
- Diskus® Deep-Welding Technology provides maximum strength and pry resistance
- Shackle made from hardened alloy steel
- Anti-cut plate
- ABUS-Plus disk cylinder: highest protection against manipulation, extremely high number of key differs, drilling and pulling protected



◀ 70mm ▶  
20/70



◀ 80mm ▶  
20/80

Item	Shackle Height	# Pins	Key Options	Case Pk Qty	Weight kg
20/70	17mm	6	KD, KA, MK	6	0.337
20/80	18mm	6	KD, KA, MK	3	0.469





## Weatherproof Diskus® 24IB

- Original Diskus® design: 360° protection
- 100% non-corrosive: shackle and all inner components made of stainless steel
- Diskus® Deep-Welding Technology provides maximum strength and pry resistance
- Precision pin cylinder - extra plated for ultimate corrosion resistance
- Available keyed-different, keyed-alike and master-keyed

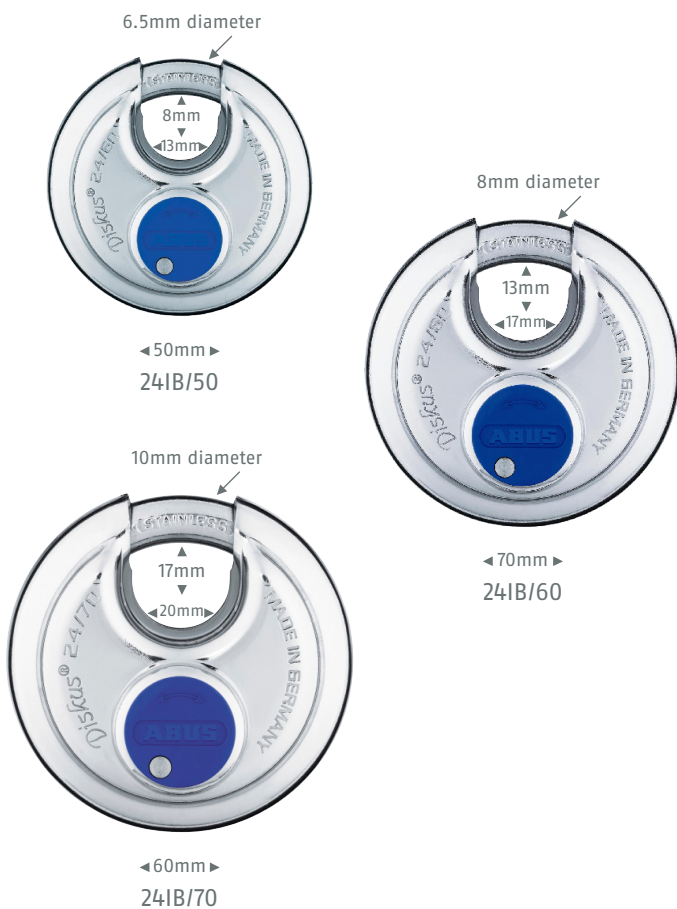

Item	Shackle Height	# Pins	Key Options	Shelf Pk Qty	Weight kg
24IB/50	8mm	4	KD, KA	6	0.113
24IB/60	13mm	4	KD, KA, MK	6	0.220
24IB/70	17mm	5	KD, KA, MK	6	0.320



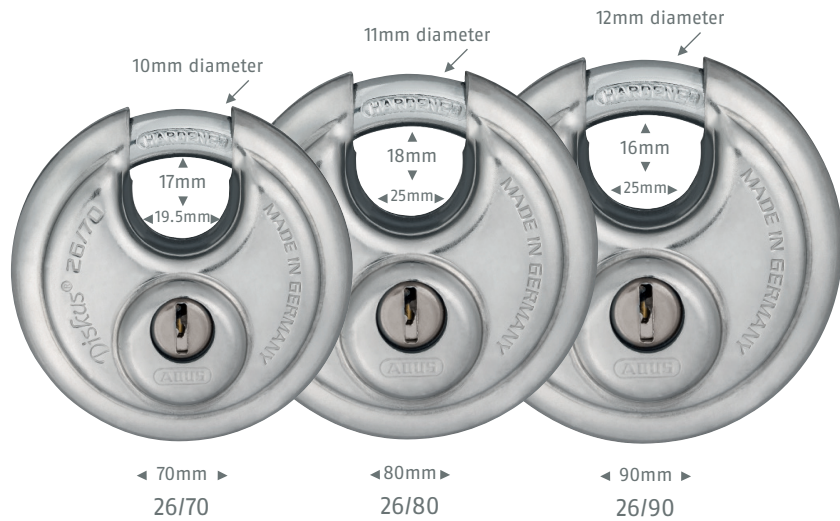
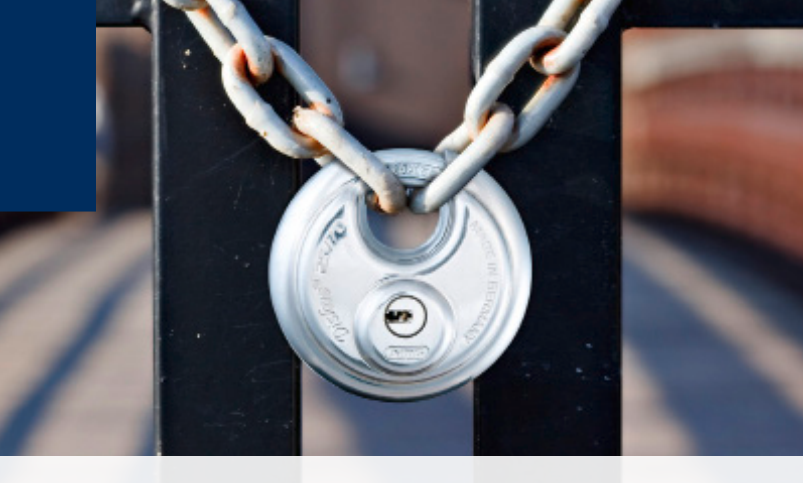

## Dimple-Key Diskus® 25

- High precision reversible key with 8,000 key differs
- Spare keys can only be ordered with assigned code
- 100% non-corrosive stainless steel inside and out
- Shackle made from hardened steel
- Original Diskus® design: 360° protection
- Anti-cut plate
- Diskus® Deep-Welding Technology provides maximum strength and pry resistance
- Key retaining: lock retains key until locked

Item	Shackle Height	# Pins	Key Options	Shelf Pk Qty	Weight kg
25/70	17mm	8	KD	6	0.323

## Stainless Steel Diskus® 26

- 100% non-corrosive stainless steel inside and out
- Massive inner base for enhanced security
- Anti-cut plate
- Shackle made from special alloy hardened steel
- Precision pin cylinder, drilling and pulling protected
- Diskus® Deep-Welding Technology provides maximum strength and pry resistance
- Original Diskus® design: 360° protection
- Key retaining: lock retains key until locked

Item	Shackle Height	# Pins	Key Options	Shelf Pk Qty	Weight kg
26/70	17mm	5	KD, KA, MK	6	0.325
26/80	18mm	6	KD, KA, MK	3	0.425
26/90	16mm	6	KD, KA, MK	3	0.633





## Hardened Steel Diskus® 28

- Original Diskus® design: 360° protection
- Diskus® Deep-Welding Technology provides maximum strength and pry resistance
- Shackle made from hardened steel
- Precision pin cylinder with anti-pick pins - extra plated for ultimate corrosion resistance
- Available keyed-different and keyed-alike

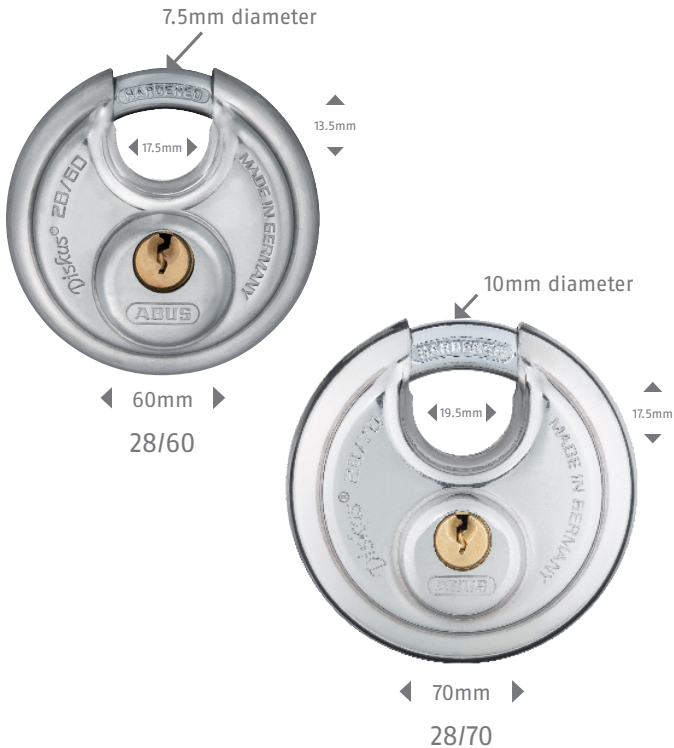

Item	Shackle Height	# Pins	Key Options	Shelf Pk Qty	Weight kg
28/60	13.5mm	4	KD, KA	6	0.177
28/70	17.5mm	5	KD, KA	6	0.249





## Brass 55

- Solid brass body offers maximum corrosion resistance
- Available with hardened steel or brass shackle (MB)
- Inner components made from non-corrosive materials
- Perfect solution for outdoor security applications
- Available keyed-different and keyed-alike

Item	Shackle Height	# Pins	Shackle Material	Shelf Pk Qty	Weight kg
55/25	11mm	3	Steel	12	0.048
55/30	14.5mm	3	Steel	12	0.066
55MB/30	14.5mm	3	Brass	12	0.066
55/40	21.5mm	4	Steel	12	0.119
55MB/40	21.5mm	4	Brass	12	

Item	Shackle Height	# Pins	Shackle Material	Shelf Pk Qty	Weight kg
55MB/40HB63	63.5mm	4	Brass	6	
55/45	24mm	4	Steel	6	0.136
55/50	24.5mm	5	Steel	6	0.180
55MB/50	24.5mm	5	Brass	6	0.180
55/60	32mm	5	Steel	6	0.327







## Brass 65

- Body made from solid brass
- Shackle made from hardened steel with NANO PROTECT™ coating
- Inner components made from non-corrosive materials
- Precision pin tumbler
- Available keyed-different and keyed-alike

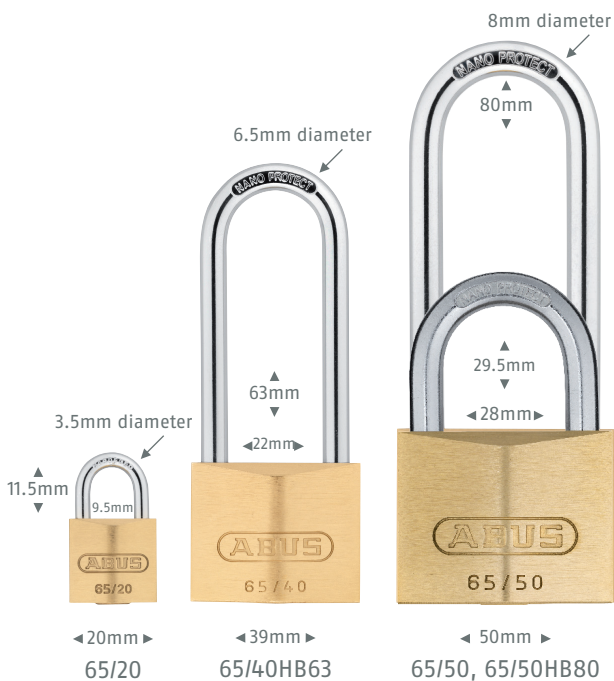

Item	Shackle Height	# Pins	Key Options	Shelf Pk Qty	Weight kg
65/20	11.5mm	3	KD, KA	6	0.036
65/25	14mm	4	KD, KA	6	0.063
65/30	17mm	4	KD, KA	6	0.073
65/40	23mm	5	KD, KA	6	0.139
65/40HB40	40mm	5	KD, KA	6	0.171
65/40HB63	63mm	5	KD, KA	6	0.183
65/45	25mm	5	KD, KA	6	0.201
65/50	29.5mm	5	KD, KA	6	0.247
65/50HB80	80mm	5	KD, KA	6	0.323
65/60	35mm	5	KD, KA	6	0.433





## Brass 85

- Body made of solid brass
- Inner components made of non-corrosive materials
- Hardened steel shackle with NANO PROTECT™ coating
- Precision pin cylinder with mushroom pins
- Paracentric keyway for increased protection against manipulation
- Can be made keyed alike to already existing keys/locks
- Automatic locking: Locking without key by pushing down the shackle

Item	Shackle Height	# Pins	Key Options	Shelf Pk Qty	Weight kg
85IB/40	22.5	5	KD, KA, MK	6	0.143
85IB/40HB63	40mm	5	KD, KA, MK	3	0.193
85/50HB80	80mm	5	KD, KA, MK	3	0.315



## Brass 88

- Lock body made from solid brass
- Chromed plated lock body for a better corrosion resistance
- Double bolted
- Shackle made from hardened alloy steel
- ABUS-Plus disc cylinder: highest protection against manipulation
- Cylinder can be re-keyed to match an existing key
- Key retaining: locking only with the key (lock retains key until locked)

Item	Shackle Height	# Pins	Key Options	Shelf Pk Qty	Weight kg
88/40	22.5mm	7	KD, KA	6	0.208
88/50	24mm	7	KD, KA	6	0.295



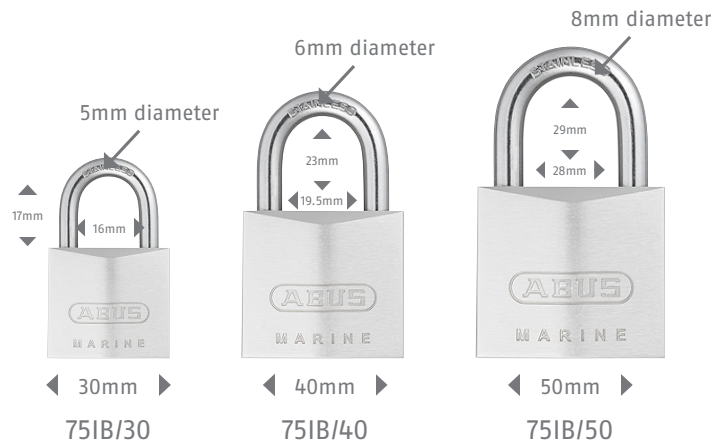
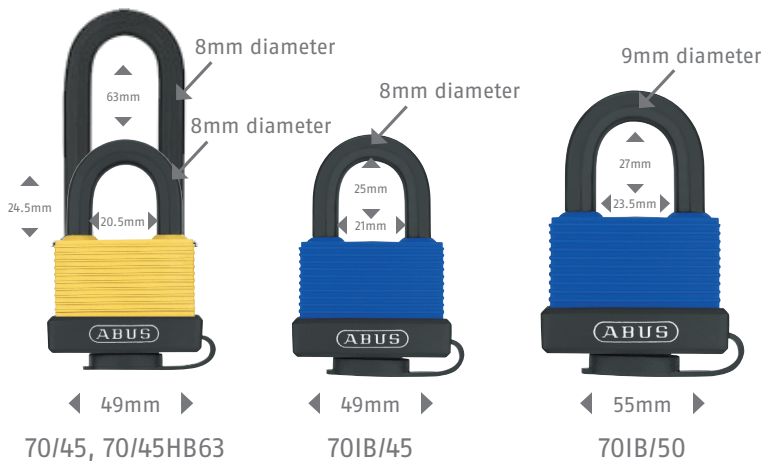

## Weatherproof Brass 70

- Solid brass body and hardened steel shackle with shock-absorbing vinyl cover provide ultimate weather resistance
- Cylinder cover with drainage channels protects padlock from water and dirt
- Inner components made from non-corrosive materials
- Available keyed-different, keyed-alike and master-keyed
- IB: comes with stainless steel shackle

Item	Shackle Height	# Pins	Key Options	Shelf Pk Qty	Weight kg
70IB/35	25mm	4	KD	12	0.106
70/45	24.5mm	5	KD, KA	6	0.164
70/45HB63	63mm	5	KD, KA	6	0.210
70IB/45	25mm	5	KD, KA, MK	6	0.193
70IB/45HB63	63mm	5	KD, KA, MK	6	0.210
70IB/50	27mm	5	KD, KA, MK	6	0.217



## Weatherproof 75

- High-precision reversible keyway with up to 150,000 key differs
- Body made from solid brass or pearl-nickel-plated brass
- Shackle made from stainless steel
- Dimple key
- Key-retaining: 75IB/40 + 75IB/50
- Self-locking: 75IB/30



Item	Shackle Height	# Pins	Key Options	Shelf Pk Qty	Weight kg
75IB/30	17mm	8	KD, KA	12	0.081
75IB/40	23mm	8	KD, KA	12	0.179
75IB/40HB/40	40mm	8	KD, KA	12	0.185
75IB/50	29mm	10	KD, KA	6	0.255





## TITALIUM 54TI™

- Solid lock body made of TITALIUM™ aluminum alloy: light, but secure
- Hardened steel shackle, difficult to cut
- Just as strong as traditional brass padlocks

Item	Shackle Height	# Pins	Key Options	Shelf Pk Qty	Weight kg
54TI/30	14mm	3	KD	6	0.047
54TI/35	16mm	3	KD	6	0.039
54TI/40	21mm	4	KD	6	0.070
54TI/40HB63	63mm	4	KD	6	0.092

## TITALIUM™ 80TI

- Solid lock body made from TITALIUM™ aluminum alloy: higher security, less weight
- Hardened steel shackle with NANO PROTECT™ coating
- Paracentric keyway for increased protection against manipulation
- Just as strong as traditional brass padlocks

Item	Shackle Height	# Pins	Key Options	Shelf Pk Qty	Weight kg
80TI/40HB40	40mm	6	KD, KA	4	0.152
80TI/50	35mm	6	KD, KA	4	0.243



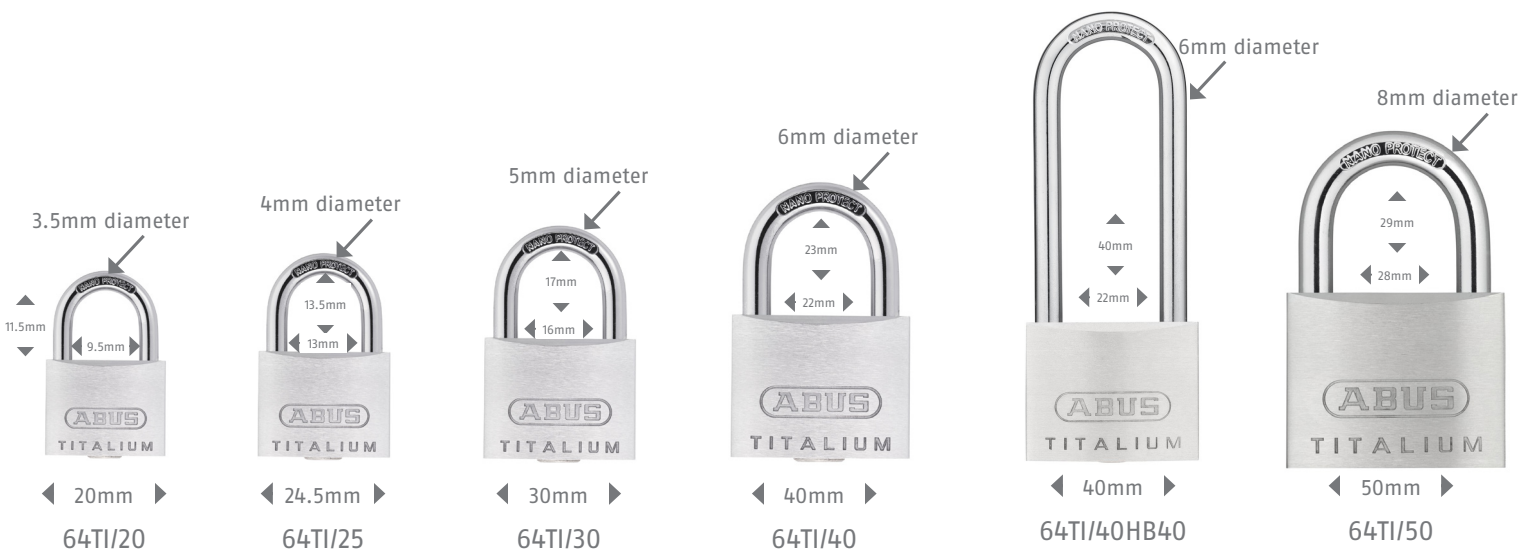

## TITALIUM™ 64TI

- Solid lock body made from TITALIUM™ aluminum alloy: higher security, less weight
- Hardened steel shackle with NANO PROTECT™ coating for superior corrosion resistance
- Paracentric keyway for increased protection against manipulation
- Just as strong as traditional brass padlocks

Item	Shackle Height	# Pins	Key Options	Shelf Pk Qty	Weight kg
64TI/20	11.5mm	3	KD	6	0.015
64TI/25	13.5mm	4	KD	6	0.025
64TI/30	17mm	4	KD	6	0.053
64TI/40	23mm	5	KD	6	0.087
64TI/40HB40	40mm	5	KD, KA	6	0.096
64TI/50	29mm	5	KD, KA	6	0.136



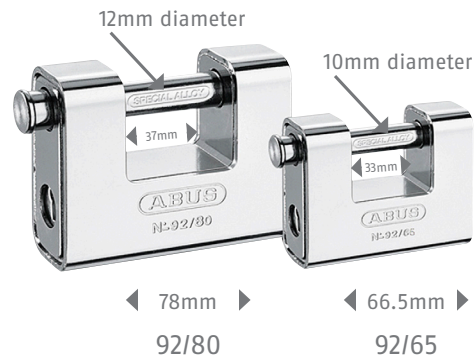
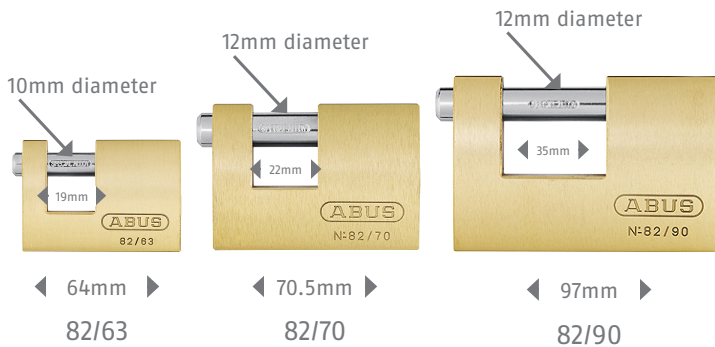

## Monoblock 82

- Brass body offers strength and rust resistance
- Unique padlock design with hardened steel shackle and pin provides maximum resistance to bolt cutters
- Ultimate security when paired with ABUS security chain
- Available keyed-different and keyed-alike

## Monoblock 92

- Body made from solid brass with steel jacket
- Hardened steel shackle with NANO PROTECT™ coating
- Precision pin tumbler
- Perfect for use with ABUS security chain

Item	# Pins	Key Options	Shelf Pk Qty	Weight kg
82/63	5	KD, KA	6	0.303
82/70	5	KD, KA	6	0.412
82/90	5	KD, KA	6	0.725

Item	# Pins	Key Options	Shelf Pk Qty	Weight kg
92/65	5	KD, KA	3	0.564
92/80	5	KD, KA	3	0.797



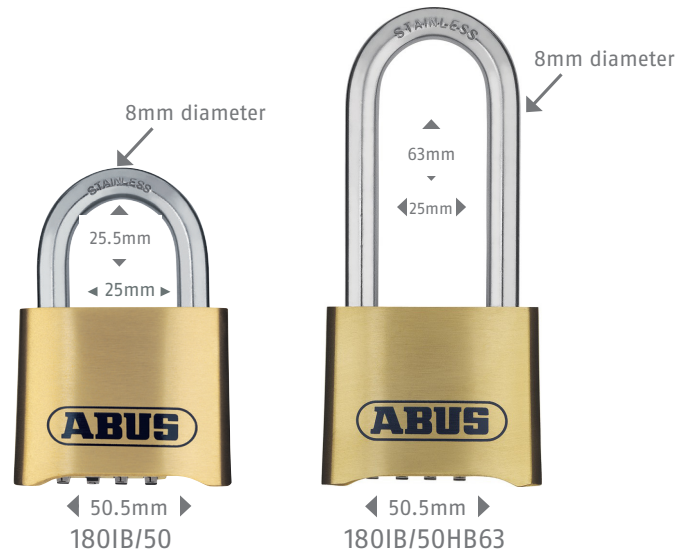

## Weatherproof 84IB

- Lock body made of nickel-plated solid brass
- Shackle made of stainless steel
- Inner components made of non-corrosive materials
- Precision pin tumbler
- Self-locking: locking without a key by pushing down the shackle

## Weatherproof Combination 180IB

- Solid forged brass body provides superior protection and weather resistance
- Stainless steel shackle and corrosion-resistant inner components for ultimate rust protection
- Precision locking mechanism with special protection against manipulation
- 4-digit resettable code
- Resetting tool included

Item	Shackle Height	Key Options	Shelf Pk Qty	Weight kg
84IB/40	21mm	KD	6	0.081
84IB/50	24mm	KD	6	0.222
84IBHB/50	50mm	KD	6	0.240

Item	Shackle Height	Dials	Shackle Material	Shelf Pk Qty	Weight kg
180IB/50	25mm	4	Steel	6	0.267
180IB/50HB63	63mm	4	Steel	6	0.300



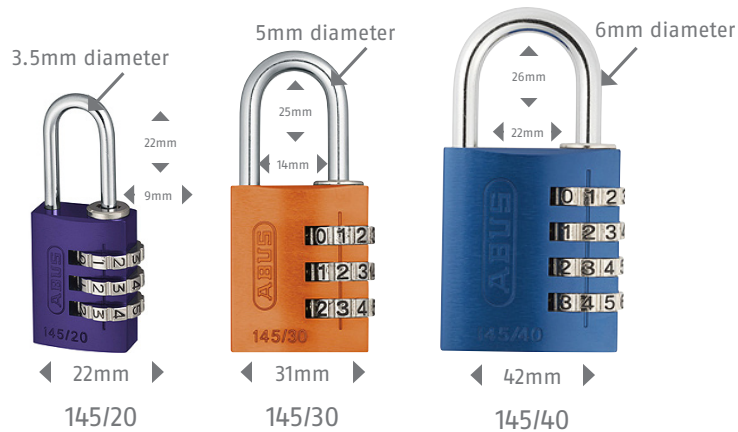
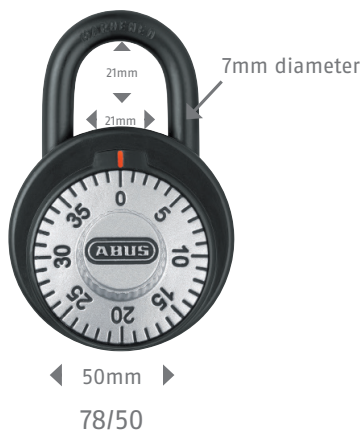
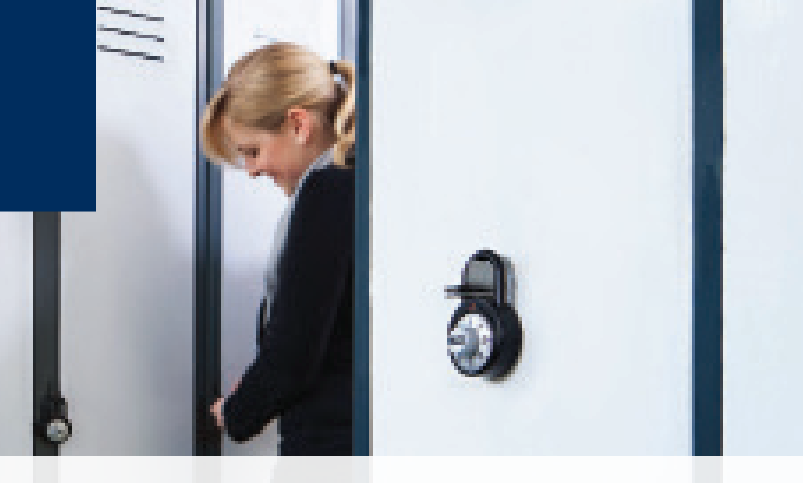

## Dial Combination 78

- 3-dial combination
- Extra protection against manipulation
- Hardened steel body
- Colored dial for individuality and easy recognition
- 78KC (Key Control): Cylinder with master key function, ideal for schools



Item	Shackle Height	# Combo	Shackle Material	Shelf Pk Qty	Weight kg
78/50	21mm	3	Steel	6	0.154
78KC/50	21mm	3	Steel	12	0.185

## Combination 145

- Solid and lightweight aluminum body
- 3- or 4-digit individually resettable code
- Ideal for securing toolboxes, luggage, lockers, cabinets and more
- Locking of cupboards and lockers at schools, sports and fitness centres



Item	Shackle Height	Dials	Shackle Material	Shelf Pk Qty	Weight kg
145/20	22mm	3	Steel	6	0.023
145/30	25mm	3	Steel	6	0.055
145/40	26mm	4	Steel	6	0.110





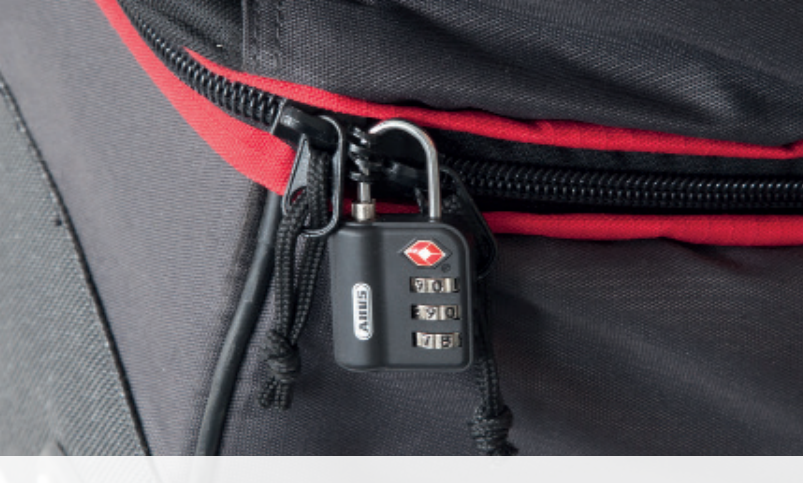

## Combination TSA 147/148

- Individually resettable 3-digit code
- Visible red indicator at shackle: lock was opened by TSA
- To reset red indicator open lock and turn shackle by 360°

## Bakpac™ 151

- Shackle diameter 1/8"
- Individually resettable 3-digit code
- Shackle opens by pressing the lever at the side

Item	Shackle Height	Dials	Shackle Material	Shelf Pk Qty	Weight kg
147TSA/30	20mm	3	Steel	12	0.046
148TSA/30	38mm	3	Cable	12	0.023



Item	Shackle Height	Dials	Shackle Material	Shelf Pk Qty	Weight kg
151/20	15mm	3	Steel	12	0.039





## Combination 155

- Hardened steel shackle
- Individually resettable 4-digit code

## Combination 158

- Solid body made of zinc die-cast
- Double bolted shackle
- Shackle made from hardened steel
- 158/40: individually resettable 3-digit code
- 158/45KC and 158/50: individually resettable 4-digit code
- 158/45KC: override key available for purchase



Item	Shackle Height	# Combo	Shackle Material	Shelf Pk Qty	Weight kg
155/40	27mm	4	Steel	6	0.150

Item	Shackle Height	Dials	Shackle Material	Shelf Pk Qty	Weight kg
158/40	26mm	3	Steel	3	0.164
158/50	32mm	4	Steel	3	0.293
158/45KC	25mm	4	Steel	12	0.177





## Steel Combination 160

- Solid chrome-plated zinc body
- Hardened steel shackle
- Polished chrome finish for superior weather resistance
- 160/40: individually resettable 3-digit code
- 160/50: individually resettable 4-digit code

## Heavy Duty Combination 190

- Heavy-duty combination lock
- Solid hardened steel jacket
- 4-digit resettable code
- Precision locking mechanism with special manipulation protection
- Shackle guard protects shackle from attacks

Item	Shackle Height	# Combo	Shackle Material	Shelf Pk Qty	Weight kg
160/40	22.5mm	3	Steel	3	0.152
160/50	26mm	4	Steel	3	0.228
160/50HB50	50mm	4	Steel	12	0.247

Item	Shackle Height	Dials	Shackle Material	Shelf Pk Qty	Weight kg
190CS/60	30mm	4	Steel	2	0.770



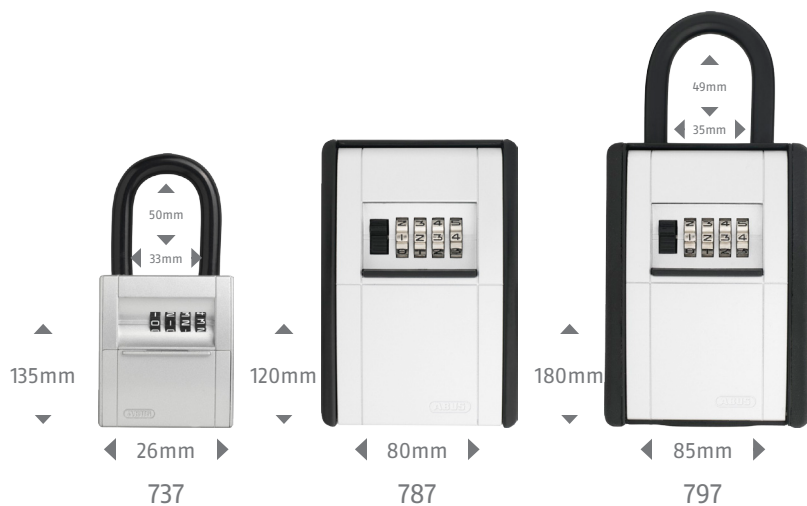
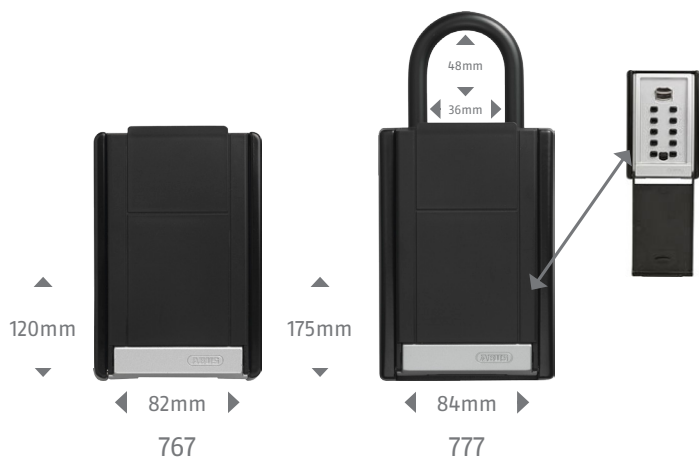

## Push Button KeyGarage™

- Large solid metal housing offers more capacity than conventional key boxes
- 10 push-button resettable combination: Set your own PIN
- Push buttons provide faster access than dials
- Large hinged front door protects buttons
- 767: For wall mounting, 777: For attaching with shackle
- Holds up to 8 cards or 20 keys

## Dial KeyGarage™

- Ideal protected storage for keys and other valuables
- Solid metal housing; locking cover made from zinc die-cast
- 4-digit individually resettable code
- Protective cover with sliding mechanism
- 787: For wall mounting, 797: For attaching with shackle
- 787, 797: Holds up to 8 cards or 20 keys
- 737: Compact KeyGarage™ holds up to 6 keys

Item	Shackle Height	# of Buttons	Shelf Pk Qty	Weight kg
767	-	10	1	0.650
777	48mm	10	1	0.750

Item	Shackle Height	# of Dials	Shelf Pk Qty	Weight kg
737	50mm	4	1	0.539
787	-	4	1	0.660
797	49mm	4	1	0.770





## Integral Hasp D1141

- Universal hasp with integrated Diskus® lock
- Ideal for use on double doors (utility vans, storage sheds)
- Easy to operate with one hand
- Solid metal locking case prevents successful attacks on the integrated padlock
- Zinc-plated for extreme corrosion resistance
- Mounting hardware included (screws, drilling template and spacers up to 1/5" height)
- Available with or without Diskus® lock



Item	Body Material	Body Colour	Shelf Pk Qty	Weight kg
D1141/200	Steel	Black	1	1.270
D1141/200	Steel	White	1	1.270



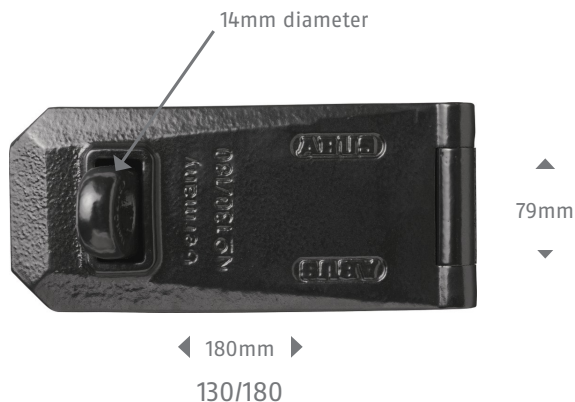

## Granit™ Hasp 130

- Two hardened hinge pins
- Tough white heart malleable iron
- Hardened staple
- Includes coach bolts and back plate



Item	Body Material	Shelf Pk Qty	Weight kg
130/180	White Heart Malleable Iron	1	1.670

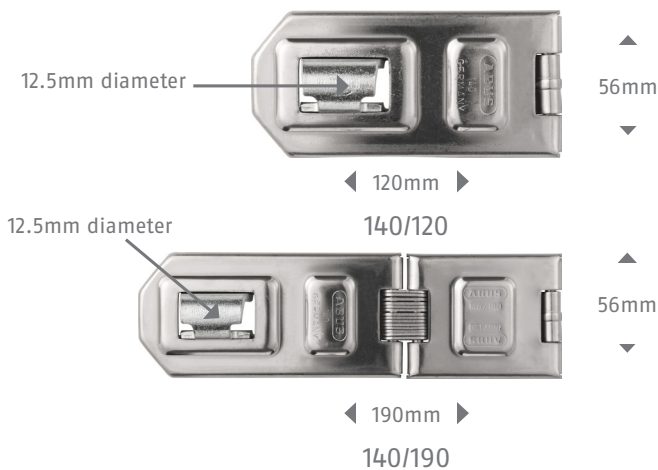

## Stainless Steel Hasp 140

- Hasp and hinge pins made of stainless steel
- Tough construction with hardened staple
- Hinge pins protected against attack
- Ideal in combination with Diskus® padlocks



Item	Body Material	Shelf Pk Qty	Weight kg
140/120	Stainless Steel	3	0.355
140/190	Stainless Steel	3	0.463



## Hardened Steel Hasp 125

- Extra-strong hinge
- Hardened staple
- Includes coach bolts and back plates
- Extremely high corrosion resistance



Item	Body Material	Shelf Pk Qty	Weight kg
125/150	Coated Hardened Steel	2	0.900

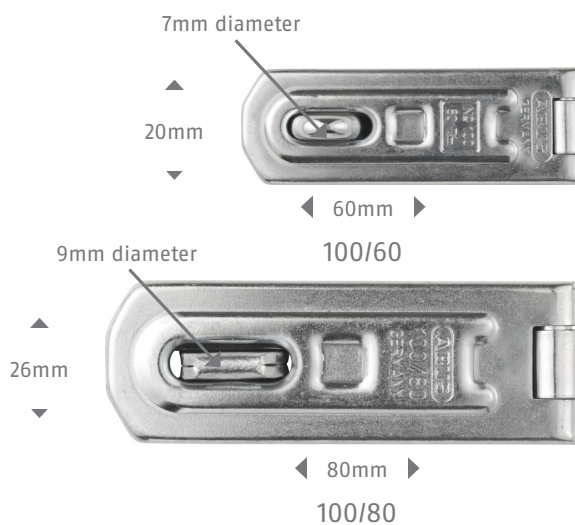

## Concealed Hinge Pin Hasp 100

- Hardened staple and hinge pins (not for 100/60)
- Concealed hinge pin
- Corrosion-protected
- Hidden screws



Item	Body Material	Shelf Pk Qty	Weight kg
100/60	Steel	3	0.019
100/80	Steel	3	0.063

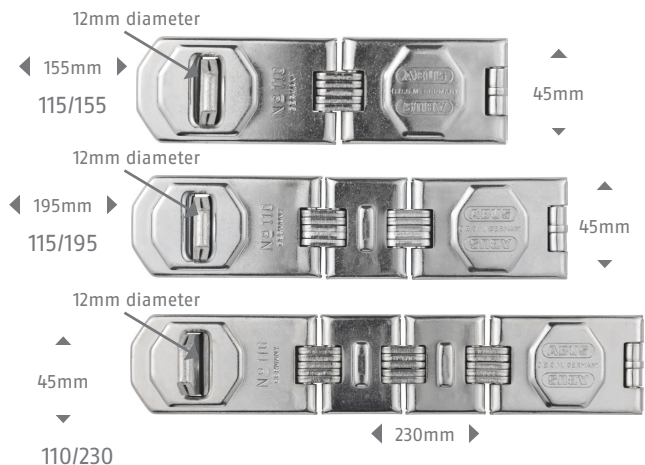

## Concealed Hinge Pin Hasp 110

- Hardened steel for extra strength
- Seamless eye loop prevents prying
- Center-lock pin resists being driven out at end
- Hidden screws and hinge pins for extra security



Item	Body Material	Shelf Pk Qty	Weight kg
110/155	Hardened Steel	3	0.277
110/195	Hardened Steel	3	0.340
110/230	Hardened Steel	3	0.413

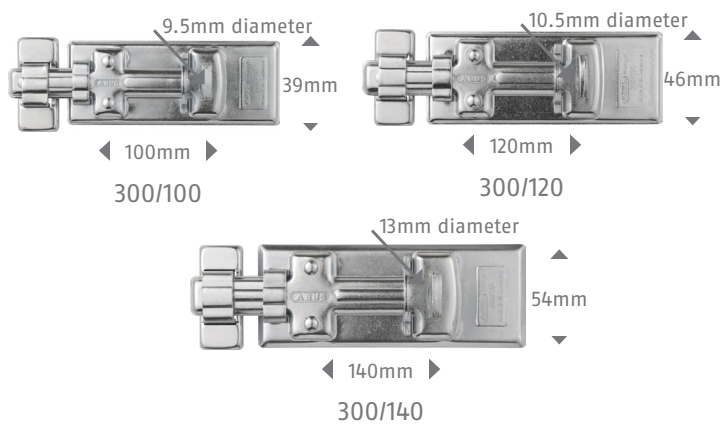

## Hardened Hasp 300

- Hardened steel sliding locking bolt
- Zinc chrome finish for corrosion protection
- Hidden screws for extra security



Item	Body Material	Shelf Pk Qty	Weight kg
300/100	Zinc-coated Hardened Steel	6	0.180
300/120	Zinc-coated Hardened Steel	6	0.250
300/140	Zinc-coated Hardened Steel	6	0.370

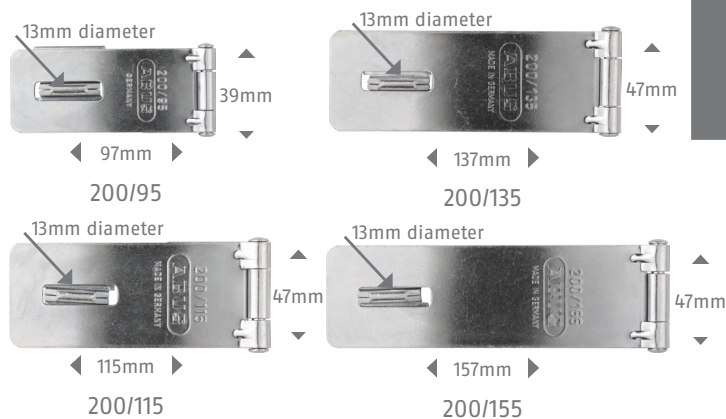

## Hardened Hasp 200

- Hardened steel for extra strength
- Galvanized finish for corrosion protection
- Seamless eye loop prevents prying
- Hidden screws and hinge pins for extra security



Item	Body Material	Shelf Pk Qty	Weight kg
200/95	Hardened Steel	6	0.121
200/115	Hardened Steel	6	0.176
200/135	Hardened Steel	6	1.99
200/155	Hardened Steel	6	0.323

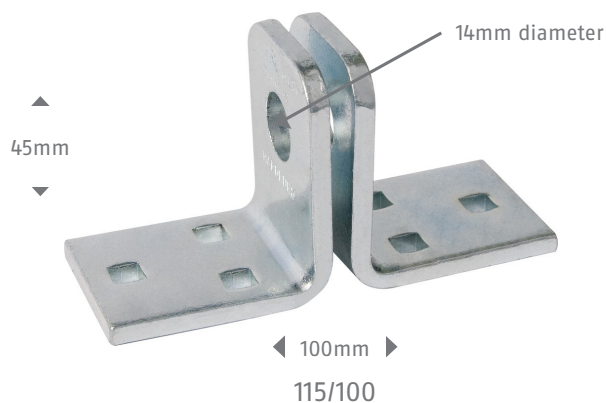

## Fixed Staple Hasp 115

- Corrosion-protected
- Hardened bolt
- Hidden screws



Item	Body Material	Shelf Pk Qty	Weight kg
115/100	Steel	6	0.258



## Maximum Security Chain

- Chain made from hardened steel
- Square-shaped links provide top security against all types of aggressive attacks
- Fabric sleeve prevents surroundings from damage
- Available in pre-cut or custom lengths
- Custom chain lengths come shipped in barrels
- Loop chain comes with a larger loop on one end, making the chain go further

Item	Cutting Force	Inside Height	Thickness	Inside Width
6KS	4 tons	29mm	6mm	9mm
8KS	6 tons	35mm	8mm	13mm
10KS	8 tons	38mm	10mm	14mm
12KS	10 tons	57mm	12mm	15mm
14KS	12 tons	50mm	14mm	20mm



6KS

8KS

10KS

12KS

14KS



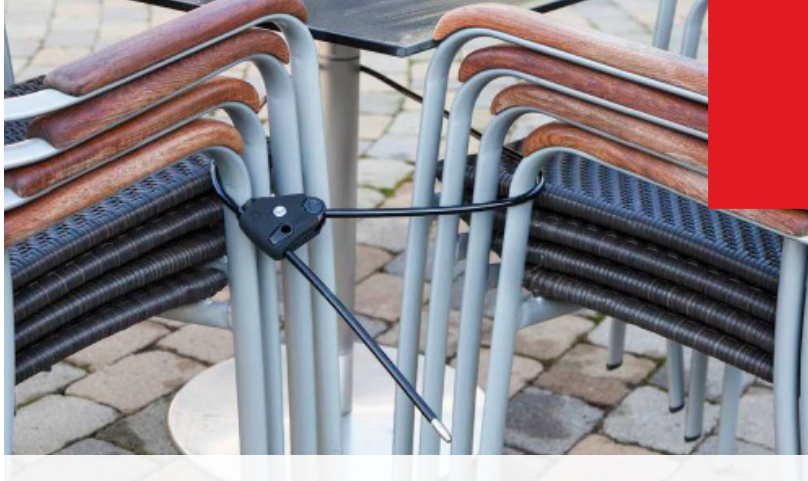

10/500 Cable



210/185

## COBRA Steel Cable

- Flexible steel cable
- ABUS loop cables protect bike components like front and rear wheel, frame and seat as the ideal complement to the ABUS U-shackle-locks, padlocks or frame locks
- Ideal to secure bicycles, surf boards, garden tools, etc.

Item	Diameter	Length	Body Material	Shelf Pk Qty	Weight kg
8/200	8mm	2000mm	Steel	1	0.317
8/250	8mm	2500mm	Steel	1	0.395
10/200	10mm	2000mm	Steel	1	0.520
10/500	10mm	5000mm	Steel	1	1.100
10/1000	10mm	10000mm	Steel	1	2.000
12/120	12mm	1200mm	Steel	1	0.416
12/180	12mm	1800mm	Steel	1	0.510
1580/185	10mm	1850mm	Steel	1	0.300

## Multiloop Cable Lock

- 24mm strong premium steel cable
- PVC-coating to prevent damage to surroundings
- Silicone coating on the lock body with "soft touch" properties for better grip
- Integrated adapter in the body for a conversion from one loop to a double-loop cable
- 210: Keyed, available keyed-alike or keyed-different

Item	Cable Diameter	Cable Length	Body Material	Shelf Pk Qty	Weight kg
210/185	10mm	1850mm	Steel	1	0.600



## File Bars

- Constructed of 16-gauge steel
- Conveniently located knob allows easy and smooth operation
- Reversible for left and right side mounting
- Available in five different lengths
- Built-in spring-loaded hinge
- Mounting screws included
- Meets the DOD's Industrial Security Requirements



Item	Shelf Pk Qty	Weight kg
1-Drawer	1	0.434
2-Drawer	1	0.781
3-Drawer	1	1.196
4-Drawer	1	1.560
5-Drawer	1	1.926



◀ 165mm ▶  
WBA100

## Floor & Wall Anchor

- 5/16" shackle made of hardened steel for extreme resistance against the most aggressive attacks
- Extra wide shackle for easy locking
- Due to its flat shape and the use of high-quality plastic, it is possible to drive over the anchor in fixed position
- Can be used indoors and outdoors as wall or floor anchor
- Includes mounting hardware

Item	Shelf Pk Qty	Weight kg
WBA100	1	2.000



▲  
120mm  
▼

◀ 220mm ▶  
215/100

## Container Lock

- Fits most common storage containers
- Also applicable for sliding doors, gates and truck doors
- Ideal for use with padlocks such as 37RK/70HB100, 37/55HB100 or 83/80HB100
- Extremely tough steel
- Manufactures with special welding technology for enhances security
- All parts corrosion-resistant

Item	Shelf Pk Qty	Weight kg
215/100	1	5.310

# Vitess™ High Security General Information

## What is ABUS Vitess™ High Security System?

The highest level of keyway security, ABUS Vitess™ High Security System is distributed under meticulous guidelines to protect the exclusivity of the individual true key profiles. Choose ABUS Vitess™ when the highest level of security and protection against unauthorized duplication is needed. ABUS Vitess™ High Security Key Control System meets the security requirements of locksmiths, distributors and end users.

ABUS locking systems offer the US market a new and innovative high security solution. Our advanced key control features are applied for patent (protection until 2034), with lifetime trademark thereafter (trademark applied). As an added security measure, we stock exclusive keyways. To increase security measures, our unique key shapes are not easily duplicated. This allows for the highest level of security.

Our high security locking systems are versatile. We work with our customers to build the right keying system for their needs. Our products are ideal for a variety of facilities, including court houses, law enforcement stations, universities, department stores, hotel and hospitality chains and much more. With our model of "local work supporting local economy," ABUS USA is proud to offer products to the US market that are stocked and assembled right here in the US.

## Highlights

- Geographic exclusivity on key blanks
- Once granted, patents protect against unauthorized key manufacture through 2034
- Vitess™ precision paracentric curved key, unique intop system and profile check pin offer increased pick resistance with lifetime trademark (if granted and always renewed)
- Drill resistant cylinder housing and plug
- Pre-loaded housing reduces assembly time, no tools or follower necessary
- Extremely high tolerance creating less wear
- All key sections and master keying available at all levels of security
- ABUS cylinders and cores can be pinned using ABUS pinning kit
- Keys can be cut with commonly available key cutting machines with the purchase of the appropriate jaws
- Thicker curved keys for added strength
- Two-year product warranty and a life-time warranty against key breakage
- Made in Germany guarantees premium quality and a long product service life

## ABUS Vitess™ Key Control Levels

ABUS Vitess™ High Security System consists of five programs:

**Level 1:** Dealer Open Non-Exclusive Keyway

**Level 2:** Regional Dealer Based Keyways, contracted to Dealer by Distributor assigned by zip code region

**Level 3:** National/Regional End-user/Institutional Exclusive Keyways, contracted and sold through normal channels of distribution

**Level 4:** National Distributor Exclusive Keyways, contracted to Dealer by Distributor

**Level 5:** State Dealer Based Keyways contracted to Dealer by Distributor

More details of each program along with initial investments can be found in the ABUS Vitess™ Price List.

## Vitess™ Keyway Information

The Vitess™ High Security system uses true keyway differs. No sidebars are used, offering a higher security level. ABUS has over 3000 true keyway differs available.

## Vitess™ Cylinder Form

Vitess™ locks and cylinders are available in two different forms:

### COM (Combinated)

Fully assembled cylinder available KD, KA, MK. Includes two cut keys.

### UNCOM (Uncombinated)

Pre-loaded housing with un-combinated cores and accessories. Key blanks sold separate.

## Master Keying

ABUS Vitess™ locks and cylinders may be master-keyed to meet virtually any requirement. Contact Tech Support to discuss special needs.

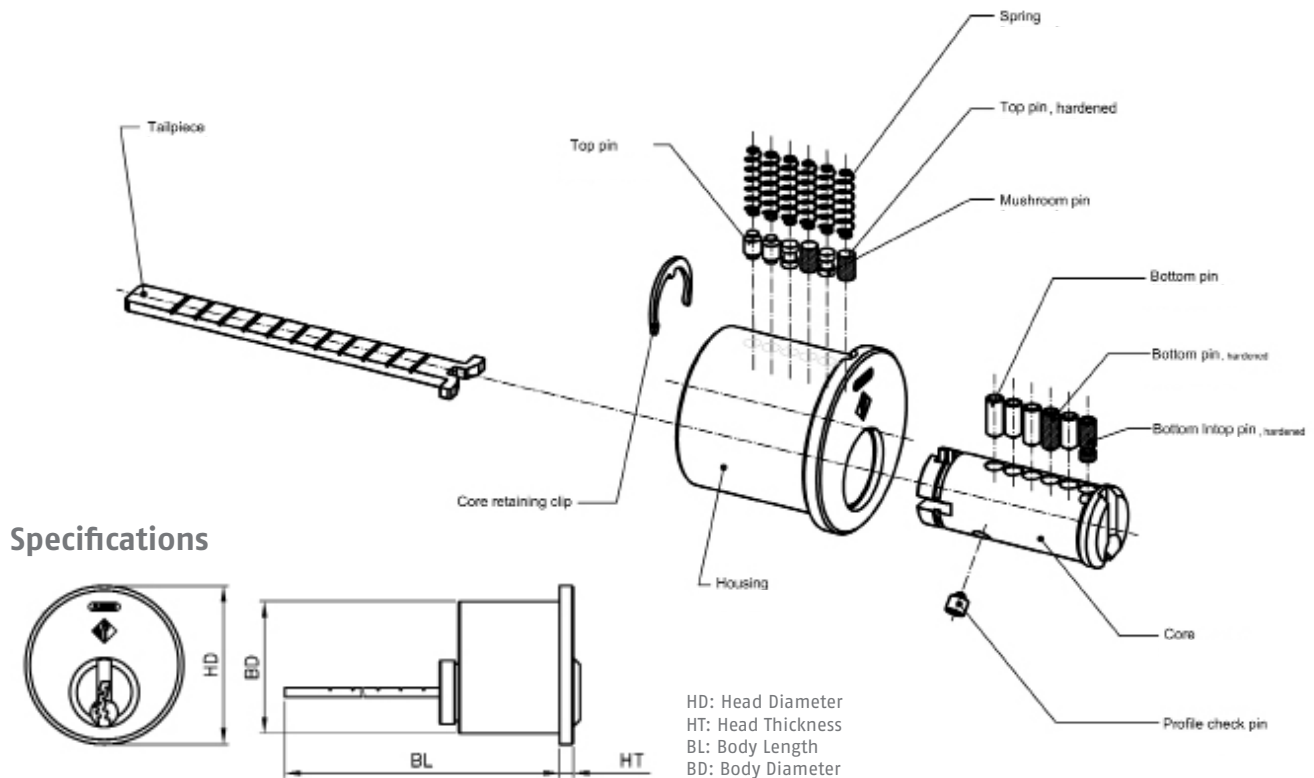

## Conventional Rim Cylinders

Commonly used on apartment and condominium doors, ABUS rim cylinders are used on vertical deadbolt locks and are also designed for commercial exit and panic devices. Rim cylinders are available with either horizontal (standard) or vertical break-off tailpiece.

### Technical

- Cylinder housing and plug are made of high quality nickel-plated brass
- Key material: nickel silver
- Technical copy protection by Intop system
- Pinning: 4 pins made of nickel silver and 2 hardened steel pins in the 1st and 3rd position for increased drill protection
- 14mm diameter core advantage – more space to allocate up to 13 pin lengths which gives extremely high combinatory capabilities



Item	HD - Head Diameter	HT - Head Thickness	BL - Body Length w/cam	BD - Body Diameter
Rim Cylinder	1.337" (33.95mm)	0.118" (3mm)	1.075" (27.3mm)	1.146" (29.1mm)

Part #	Description
10511	Rim Pre-Load Housing, Horizontal Tailpiece and Retaining Clip
10597	Rim Pre-Load Housing with Uncombined Core, Horizontal Tailpiece and Retaining Clip (Level 2, 3, 4, 5)
10514	Rim Cylinder Combined KD/KA, Horizontal Tailpiece w/ 2 cut keys
10599	Rim Core Uncombined (Level 2, 3, 4, 5)

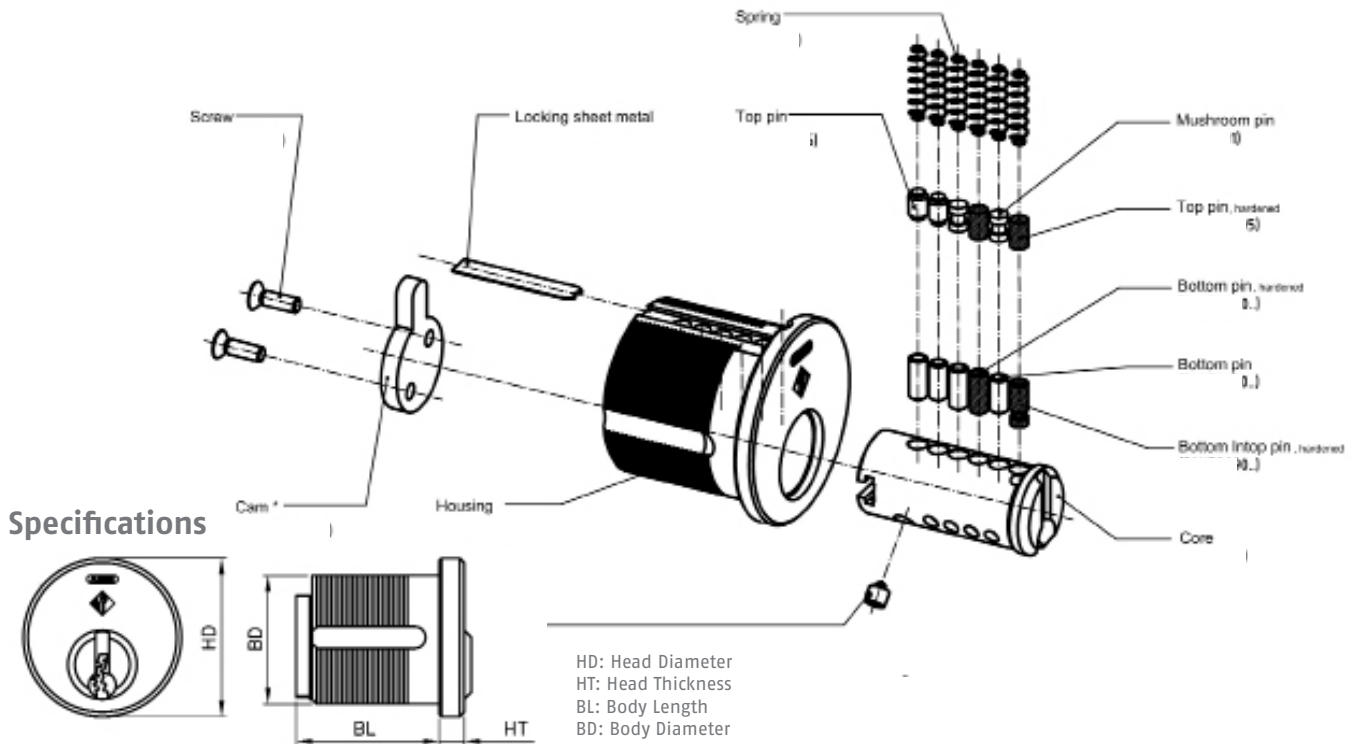

## Conventional Mortise Cylinders

ABUS Vitess™ mortise cylinders are designed to replace several original manufacturers' cylinders in their locksets offering the highest level of security available on the market today. Made to standard U.S. dimensions, these rugged cylinders are available in a variety of finishes and lengths.

### Technical

- Currently available in mortise housing lengths 1 1/8" and 1 1/4" with core extension
- Technical copy protection by Intop system
- Cylinder housing and plug are made of high quality nickel-plated brass
- Key material: nickel silver
- 5 mortise cam options available
- Pinning: 4 pins made of nickel silver and 2 hardened steel pins in the 1st and 3rd position for increased drill protection
- 14mm diameter core advantage – more space to allocate up to 13 pin lengths which gives extremely high combinatory capabilities



Item	HD - Head Diameter	HT - Head Thickness	BL - Body Length w/cam	BD - Body Diameter
1-1/8" Mortise Cylinder	1.370" (34.8mm)	0.138" (3.5mm)	1.042" (26.47mm)	1.150" (29.2mm)
1-1/4" Mortise Cylinder	1.370" (34.8mm)	0.138" (3.5mm)	1.200" (30.47mm)	1.150" (29.2mm)

# Conventional Mortise Cylinders

## Mortise Cylinder Part Numbers

Part #	Description
10500	Mortise 1-1/8" Pre-Load Housing, Adams Rite® Cam
10585	Mortise 1-1/8" Pre-Load Housing, w/o Cam
10586	Mortise 1-1/8" Pre-Load Housing with Uncombined core, Adams Rite® Cam (Level 2, 3, 4, 5)
10587	Mortise 1-1/8" Pre-Load Housing with Uncombined Core, w/o Cam (Level 2, 3, 4, 5)
10501	Mortise 1-1/8" Cylinder Combined KD/KA, Adams Rite® Cam w/ 2 cut keys
10589	Mortise 1-1/8" Cylinder Combined KD/KA, w/o Cam w/ 2 cut keys
10590	Mortise 1-1/4" Pre-Load Housing w/core extension, Adams Rite® Cam
10591	Mortise 1-1/4" Pre-Load Housing w/core extension, w/o Cam
10592	Mortise 1-1/4" Pre-Load Housing with Uncombined Core, Adams Rite® Cam (Level 2, 3, 4, 5)
10593	Mortise 1-1/4" Pre-Load Housing with Uncombined Core, w/o Cam (Level 2, 3, 4, 5)
10594	Mortise 1-1/4" Cylinder Combined KD/KA, Adams Rite® Cam w/ 2 cut keys
10595	Mortise 1-1/4" Cylinder Combined KD/KA, w/o Cam w/2 cut keys
10596	Mortise Uncombined Core (for 1-1/8" and 1-1/4") (Level 2, 3, 4, 5)

## Cams for Conventional Mortise Cylinders



Order Code	SZ01	SZ06	SZ09	SZ11	SZ12
Description	Mortise Cam (Adams Rite®)	Mortise Cam (Schlage® L)	Mortise Cam (Sargent®)	Mortise Cam (Corbin Russwin®)	Mortise Cam (Yale®)

Part #	Description
10506	SZ01 Mortise Cam (Adams Rite®) *Standard Cam
10507	SZ06 Mortise Cam (Schlage® L)
10508	SZ09 Mortise Cam (Sargent®)
10509	SZ11 Mortise Cam (Corbin Russwin®)
10510	SZ12 Mortise Cam (Yale®)

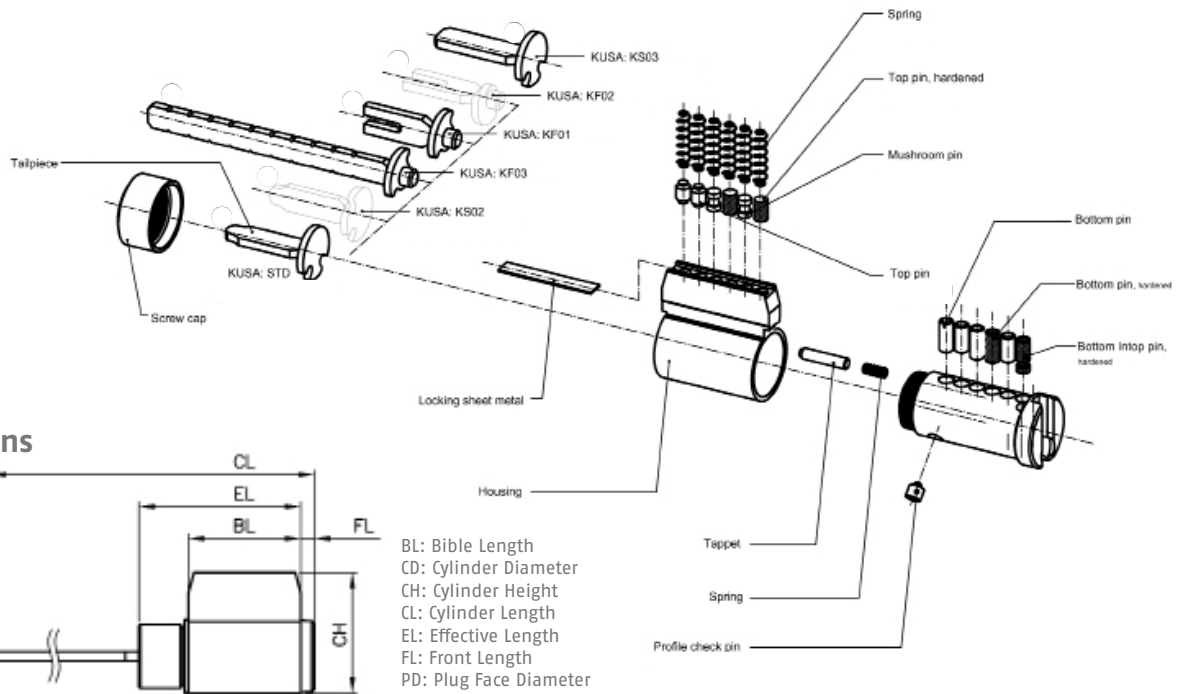

## Specifications

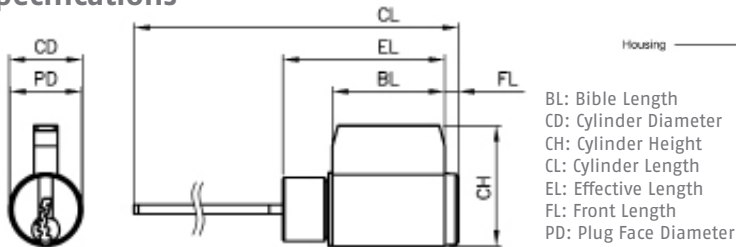

## Key-in-Knob/Lever, Deadbolt Cylinders

ABUS Vitess™ Key-in-Knob/Key-in-Lever and Deadbolt cylinders are designed to replace several original manufacturers' cylinders in their locksets offering the highest level of security available on the market today. These cylinders are manufactured to exact manufacturers' specifications to ensure precise fit and operation. ABUS Key in Knob/Key in Lever cylinders will improve the security of standard cylindrical locksets by Schlage® type cylinders.

### Technical

- Cylinder housing and plug are made of high quality nickel-plated brass
- Key material: nickel silver
- Technical copy protection by Intop system
- Fixed tailpieces at the cylinder can be adjusted to horizontal or vertical orientation
- Tailpieces for free wheel function can be adjusted to different free-wheel positions. Free-wheel 180°
- Pinning: 4 pins made of nickel silver and 2 hardened steel pins in the 1st and 3rd position for increased drill protection
- 14mm diameter core advantage – more space to allocate up to 13 pin lengths which gives extremely high combinatory capabilities

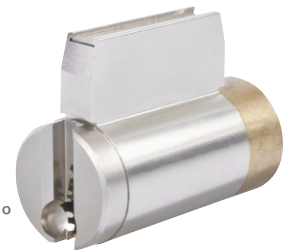

Item	BL - Bible Length	CD - Cylinder Diameter	CH - Cylinder Height	CL - Cylinder length	EL - Effective Length	FL - Front Length	PD - Plug Face Diameter
KiK/KiL Cylinder	1.024" (26mm)	0.634" (16.1mm)	1.039" (26.4mm)	*see below	1.290" (32.76mm)	0.110" (2.8mm)	0.622" (15.8mm)
Tailpieces (*Cylinder length depends on tailpiece)			STD	KF03	KF01	KS03	
			Cylinder Length	2.15" (54.66mm)	3.62" (91.91mm)	2.07" (52.66mm)	2.21" (56.06mm)

### Key-in-Knob, Key-in-Lever and Deadbolt Cylinder Part Numbers

Part #	Description
10519	KnK/KiL Pre-Load Housing w/Tailpieces (4pk)
10600	KnK/KiL Pre-Load Housing with Uncombined Cylinder Core and Tailpieces (4pk) (Level 2, 3, 4, 5)
10520	KnK/KiL Cylinder Combined KD/KA w/Tailpieces (4pk) w/2 cut keys
10602	KnK/KiL Uncombined Core (Level 2, 3, 4, 5)



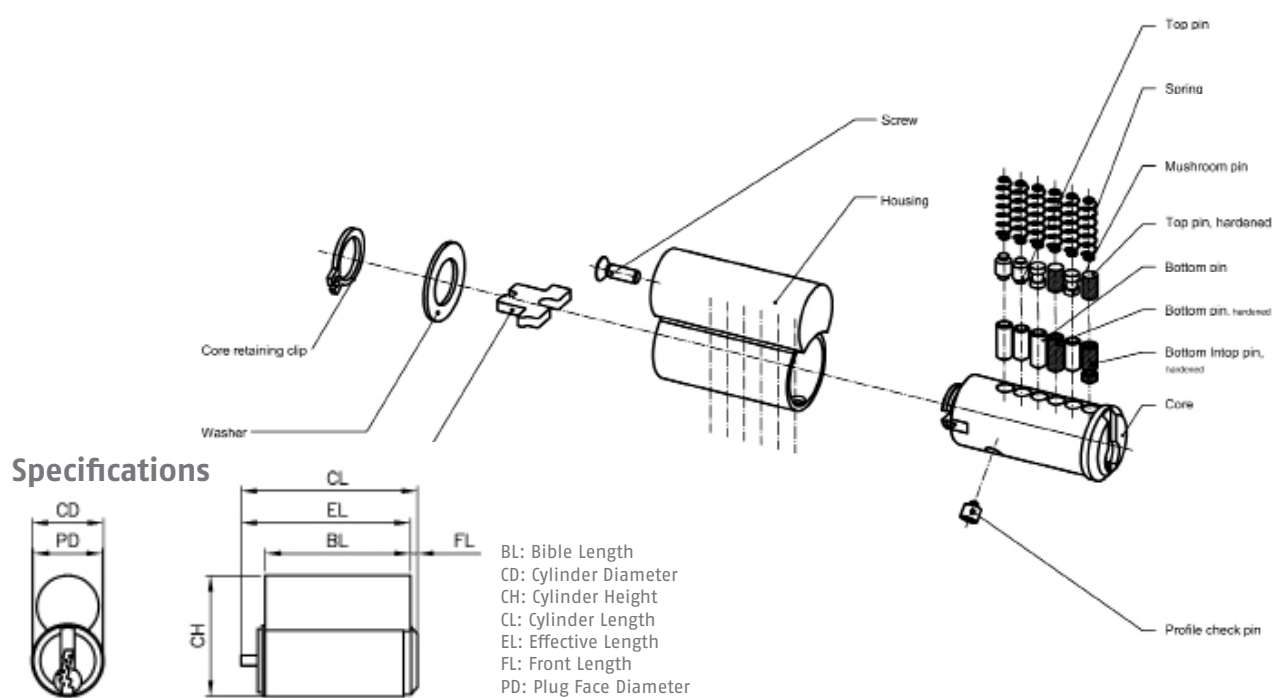

## 83 Series™ Cylinder Insert

ABUS manufactures heavy duty padlocks made from the highest quality materials that withstand the most rigorous testing procedures. Vites™ 83 cylinder insert can be used together with ABUS 83 Series™ padlocks, now offering patented key control. The locking insert can be pinned without disassembling the core for quick assembly. ABUS padlocks are used in a wide variety of applications including storage rooms, perimeter fences, armories and more.



### Technical

- Cylinder and housing made of high quality nickel-plated brass
- Key material: nickel silver
- Technical copy protection by Intop system
- Pinning: 4 pins made of nickel silver and 2 hardened steel pins in the 1st and 3rd position for increased drill protection
- 14mm diameter core advantage – more space to allocate up to 13 pin lengths which gives extremely high combinatory capabilities



Item	BL - Bible Length	CD - Cylinder Diameter	CH - Cylinder Height	CL - Cylinder length	EL - Effective Length	FL - Front Length	PD - Plug Face Diameter
83 Insert	1.283" (32.6mm)	0.632" (16.05mm)	1.053" (26.75mm)	1.526" (38.75mm)	1.490" (37.85mm)	0.035" (0.9mm)	0.587" (14.9mm)

### 83 Series Cylinder Insert Part Numbers

Part #	Description
10525	83 Series™ Pre-Load Housing
10603	83 Series™ Pre-Load Housing with Uncombined Core (Level 2, 3, 4, 5)
10526	83 Series™ Padlock Cylinder Combined KD/KA w/2 cut keys
10605	83 Series™ Cylinder Uncombined Core (Level 2, 3, 4, 5)

# Tumbler Pins

ABUS Vitess™ system uses its own pins.

## Technical

- ABUS Vitess™ 14mm core allows for much more space to allocate more pin lengths
- Main competitors have a smaller core diameter
- Longer pins for less wear on pins and key top
- Pins made of nickel silver including hardened steel drill protection pins in the 1st and 3rd position



## Tumbler Pin Part Numbers

Part #	Description
10536	Bottom Pin InTop "hardened steel" no. 5
10537	Bottom Pin "hardened steel" no. Z
10538	Bottom Pin "hardened steel" no. Y
10539	Bottom Pin "hardened steel" no. X
10540	Bottom Pin "hardened steel" no. 0
10541	Bottom Pin "hardened steel" no. 1
10542	Bottom Pin "hardened steel" no. 2
10543	Bottom Pin "hardened steel" no. 3
10544	Bottom Pin "hardened steel" no. 4
10545	Bottom Pin "hardened steel" no. 5
10546	Bottom Pin "hardened steel" no. 6
10547	Bottom Pin "hardened steel" no. 7
10548	Bottom Pin "hardened steel" no. 8
10549	Bottom Pin "hardened steel" no. 9
10550	Bottom Pin "nickel silver" no. Z
10551	Bottom Pin "nickel silver" no. Y
10552	Bottom Pin "nickel silver" no. X
10553	Bottom Pin "nickel silver" no. 0
10554	Bottom Pin "nickel silver" no. 1
10555	Bottom Pin "nickel silver" no. 2
10556	Bottom Pin "nickel silver" no. 3
10557	Bottom Pin "nickel silver" no. 4
10558	Bottom Pin "nickel silver" no. 5

Part #	Description
10559	Bottom Pin "nickel silver" no. 6
10560	Bottom Pin "nickel silver" no. 7
10561	Bottom Pin "nickel silver" no. 8
10562	Bottom Pin "nickel silver" no. 9
10575	Profile Check Pin
10563	Master Wafer no. 2
10564	Master Wafer no. 3
10565	Master Wafer no. 4
10566	Master Wafer no. 5
10567	Master Wafer no. 6
10568	Master Wafer no. 7
10569	Master Wafer no. 8
10570	Master Wafer no. 9
10571	Master Wafer no. 10
10572	Master Wafer no. 11
10573	Master Wafer no. 12
10574	Master Wafer no. 13
10608	Top Mushroom Pins
10609	Top Pin "hardened steel"
10610	Top Pin "nickel silver"
10611	Top Pin "hardened steel" (only used for cut 8/9)
10612	Top Pin "nickel silver" (only used for cut 8/9)
10613	Top Housing Spring

# Spare Parts and Components

## Mortise Cylinder Components Part Numbers

Part #	Description
10619	Mortise Cylinder Core Extender for 1-1/4"
10513	Cylinder Fixing Bolt for Mortise Cam (Pkg 50)

## RIM Cylinder Components Part Numbers

Part #	Description
10512	Rim Core Retaining Clip (Pkg 50)
10577	Rim Cylinder Tailpiece Horizontal
10620	Rim Cylinder Tailpiece Vertical



## KnK/KiL Cylinder Components Part Numbers

Part #	Description
10578	KnK/KiL Screw Cap
10579	KnK/KiL Tappet
10580	KnK/KiL Spring
10621	KnK/KiL Tailpieces (4pk)

## 83 Padlock Cylinder Insert Parts

Part #	Description
10581	83 Series™ Cylinder Core Retaining Clip
10582	83 Series™ Cylinder Core Washer
10583	83 Series™ Cylinder Core Tailpiece
10584	83 Series™ Cylinder Core Retaining Screw



# Keys and Keying

All ABUS keys are manufactured from the highest quality nickel silver material. The key's paracentric curved profile provides higher protection against picking and manipulation and key copy protection. The key bow size is perfect for easy identification and handling.

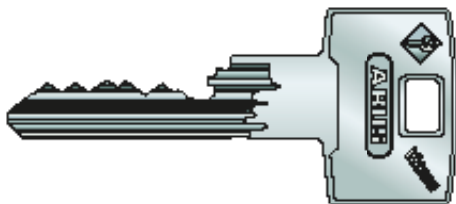

## ABUS Vitess™ Key Blanks

- Innovative key design protected by U.S. and international intellectual property rights
- Patent applied key control offers the ultimate in high security
- Able to cut on most popular key machines with the purchase of appropriate jaw
- Custom coining die required for all programs, excluding Level 1 Open Locksmith Keyway
- Custom coining die with customers name or logo requires one time setup die fee of \$250 net. If initial order is 1000 keys (blank or cut), setup die fee is waived
- Graphic/Logos available upon request with no extra surcharge
- **Specify keyway when reordering**
- **NOTE:** Key blanks available in multiples of 100 only. Minimum order quantity of 500 for coined keys (cut or blank).

Part #	Description
10531	Vitess™ Key Blanks (Pkg 100)
10606	Vitess™ Cut Key

## Pinning Kit

ABUS provides all the necessary tools for both the retail and institutional locksmith to service and maintain our locks in the field. The ABUS Vitess™ pinning kit is set up modularly, making it easy to access the parts needed.

- The ABUS Vitess™ pinning kit is a stable, durable plastic kit, which comes with all necessary components for the Vitess™ High Security program.
- The threefold latch with two buckles and a safety cover prevents unintentional opening.

Part #	Description
10531	Vitess™ Key Blanks (Pkg 100)

## Technical

- High quality nickel silver material
- Key combination is read from tip to bow
- No. 9 pin is the longest with the deepest cut, No. 2 pin is the shortest, with the shallowest cut
- For pinning rules, please reference ABUS Vitess™ Service Manual

## Warranty

ABUS guarantees that if a key should break under normal usage, ABUS will replace it at no charge

## Form

ABUS Vitess™ Personalized Key Program Form, AV#28 needs to be completed and returned to ABUS USA to order your custom coined keys. This is required for all levels with the exception of Level 1, which is not available for custom coined keys.

## Managing Key Blank Inventory

It is important to keep an accurate record of key blank inventory and a detailed log of keys issued in case a question arises. Each incoming order of ABUS Vitess™ blanks should be logged with a transaction on a Restricted Key Order Form, signed and dated by the employee who received and counted the blanks. All inaccurate cuts should also be documented on one of these forms, signed and dated by the employee who handled the transaction and logged into the main book. The total number of key blanks received, minus inaccurate cuts and keys issued, should always equal the number still on hand. The dealer should reconcile the log periodically and also log any discrepancies at that time. Discrepancies may indicate a breach in security or a careless employee.

## Pinning Kit Contents

- Index with item numbers
- Labels for the single inserts
- Includes: Top and bottom hardened steel pins, top and bottom nickel silver pins, housing top springs, master wafers, profile check pin, mortise cams



# Security Card

## Technical

- ABUS Vitess™ Security Cards are used as authorization for the Vitess™ program
- Cards have a signature panel on the back and are issued by the servicing locksmith who directly supports the system owner
- The owner must present the I.D. card to obtain duplicate keys or additions to his system
- The signature will be validated by the dealer

Part #	Description
10622	Vitess™ Security Signature Card
10623	Vitess™ Security Signature Card - Duplicate/Replacement

## Forms

- ABUS Vitess™ Security Card Order Form #AV27 needs to be completed and returned to ABUS USA to order your customized security cards
- ABUS Vitess™ Security Card Signature Registration Form #AV25 is kept on file with the Dealer for signature validation of the purchasing owner of the program



# Supplies, Service Equipment & Tools

Part #	Description
10615	Complete Assembly Tool Kit
10616	Grooved Follower
10617	Filling Device 3pc Kit
10618	Plastic Plugs



Assembly Tool Kit



Follower



Filling Device

## Forms

All ABUS Vitess™ forms can be found online at [www.abus.com/us/vitess](http://www.abus.com/us/vitess).

### #AV21 Vitess™ Confidentiality Agreement

All who purchase a Vitess™ program sign this document and return to ABUS USA.

### #AV22 Vitess™ Distributor Agreement

Distributor, Dealer and ABUS USA sign this agreement when purchasing a Vitess™ program (Level 2 and higher). Distributor returns signed agreement to ABUS USA for signatures. ABUS USA returns fully executed agreements back to the Distributor and Dealer for their records.

### #AV23 Vitess™ Dealer Agreement

Distributors have their Dealer sign this form when purchasing a Vitess™ program. The Distributor returns 3 originals to ABUS for signature and ABUS returns fully executed agreements back to Distributor to keep on file and Dealer.

### #AV24 Vitess™ Source Authorization Form

This form is used if you already own a Vitess™ program and have a need to request another Distributor source for your program. This form is completed and returned to ABUS USA.

### #AV25 Vitess™ Security Card Signature Registration Form

This form is for the Dealers to keep record of purchasing owners of a Vitess™ system. The owner signs the form and their security card for future verification when ordering duplicate keys or products. The Dealer keeps this form for their records on file.

### #AV26 Vitess™ Master Key Request Form

This form is completed when ordering a master key system and returned to ABUS USA

### #AV27 Vitess™ Security Card Order Form

This form is completed to order customized security cards with the Dealer's name on it and Dealer's Account numbers assigned by the Distributor they purchased the program from. This form needs to be returned to ABUS USA to order the security cards. (Required for levels 2-5)

### #AV28 Vitess™ Personalized Key Program Order Form

This form is completed to order your personalized coined keys and returned to ABUS USA. (Required for levels 2-5) Level 1 is not available for coined keys.



# Service

## ABUS Charting

Available for KA, KD or MK locks

- End-user is checked by our proprietary charting software to see if we have shipped an order in the past
- All codes that have been shipped in the past are automatically excluded from production
- The codes used in an order are then double-checked and entered by in-house customer service professional
- Over 40,000 unique codes available and possibility to create more unique key differs
- Charting across multiple series is available to unlock the full potential of the diverse safety lock offering: 41 Series, 72 Series and 74 Series



# ULE Validated



ABUS's largest factory recently received a prestigious validation from Underwriters Laboratories Environment (ULE). All products manufactured in this facility including brass padlocks, steel padlocks, plastic padlocks, aluminum padlocks, and combination padlocks along with brass cylinders are now ULE validated. These products are manufactured

in the first facility in the world to achieve virtually zero waste to landfill operations in 2012 at a 98% diversion rate.

In addition, the ABUS aluminum 72 series and non-conductive 74 series have been awarded a further recognition from ULE, meeting the requirements for a "recycled content" ULE claim validation. These products contain a combined average of 73% recycled materials.

All padlocks offered in the Ecolution™ Series are also made with cadmium-free plating, recycled materials and FDA approved lubricants and are produced in a zero-waste facility.

# Merchandising

The images on this page represent a small sampling of our retail display offerings. ABUS offers a wide variety of merchandising options and custom planogram assortments. Contact us to learn more!





TITANIUM™ Counter Display



Custom Safety/Industrial Supply Planogram

# Icon Glossary

 **100% RUST-FREE**  
All parts of the lock are made from non-corrosive materials

 **CORROSION RESISTANT**  
Highly corrosion resistant due to surface protection

 **PARACENTRIC KEYWAY**  
Resists professional picking by special key profile

 **DRILL PROTECTION**  
Cylinder is protected against drilling and leverage

 **BOLT CUTTER PROTECTION**  
Bolt cutter attack resistant

 **SAW RESISTANT**  
Saw attack resistant

 **HAMMER RESISTANT**  
Hammer & impact attack resistant

 **HARDENED SHACKLE**  
Shackle made from hardened steel

 **CORROSION PLATING**  
Sophisticated plating for extreme corrosion resistance

 **ALUMINUM ALLOY**  
Lock body made from special aluminum alloy - light but secure

 **GERMANY**  
Development and production in Germany

 **SHACKLE GUARD**  
Shackle access restricted, protecting shackle from attack

 **STEEL BALL LOCKING**  
Solid steel ball locking

 **DOUBLE-BOLTED**  
Both sides of the shackle are secured by bolts or balls – increased protection against attacks and manipulation

 **SELF-LOCKING**  
The lock is locked automatically by pushing down the shackle – no key needed for locking

 **KEY-RETAINING**  
A key is needed for locking. Lock retains key until locked

 **RK AVAILABLE**  
Cylinder can be taken out and can be rekeyed to match an existing key

 **KA AVAILABLE**  
Available keyed-alike (several locks with the same key)

 **MK AVAILABLE**  
Available master-keyed (one key opens many different locks)

 **RESETTABLE CODE**

 **ABUS-PLUS**  
Original ABUS-Plus disk cylinder – highest precision, highest security

 **DIMPLE KEY**  
No sharp edges and can be inserted either way up

 **LED KEY**

 **CODE CARD**  
Spare keys are made only upon presentation of Code Card

 **SAMPLE KEY AVAILABLE**  
New locks can be made up to a sample key

 **UL VALIDATED**

 **SUSTAINABLE SOLUTIONS**

# Key Blanks

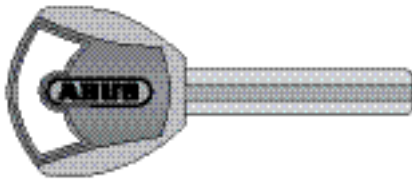

**90040 ABUS PLUS**

Works with: 20, 37, 88

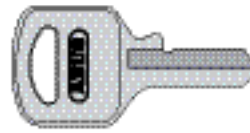

**90130**

Works with: 55/25, 54TI/25

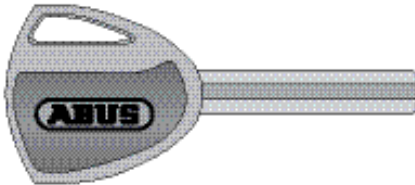

**90042 ABUS PLUS LED**

Works with: 20, 37, 88

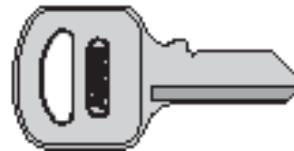

**90140**

Works with: 55/30, 54TI/30

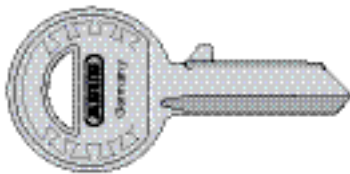

**KBR: 90010, KBL: 90020**

Works with: 24IB/(50, 60, 70) 28/70KA, 41/(30, KA/MK 4-pin)

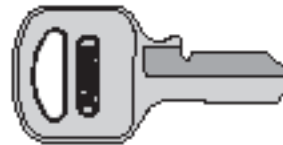

**90140**

Works with: 55/35, 54TI/35

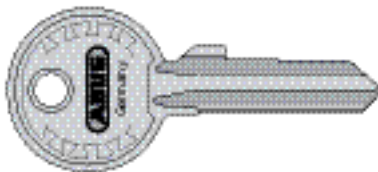

**KBR: 90015, KBL: 90016**

Works with: 24IB/70KD, 24RK, 26, 28/70, 41KD 5-pin

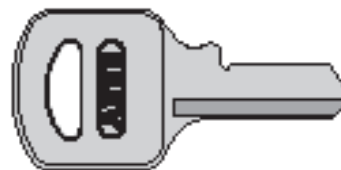

**90150**

Works with: 55/40, 54TI/40

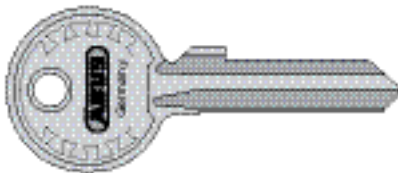

**KBR: 90420, KBL: 90430**

Works with: 24, 26, 82/(62, 70), 92/65 5-pin

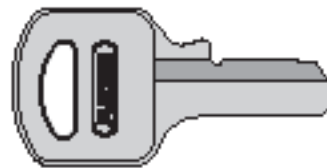

**90160**

Works with: 55/45, 54TI/45

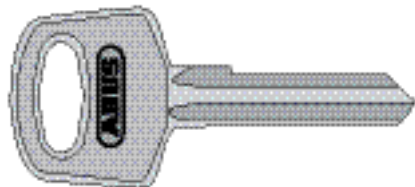

**90085**

Works with: 34/55, 34CS/55

**90018**

72/40, 74

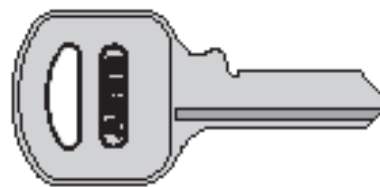

**90170**

Works with: 55/50, 54TI/50



# Key Blanks

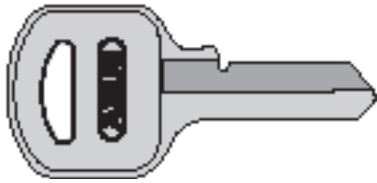

**90180**

Works with: 55/60, 54TI/60

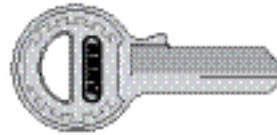

**90220**

Works with: 65/20



**90185**

Works with: 64TI/20

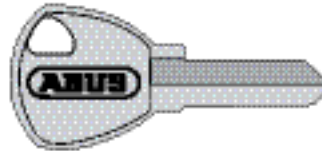

**90230**

Works with: 65/30 + 35 Old

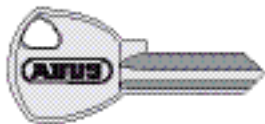

**90184**

Works with: 64TI/25

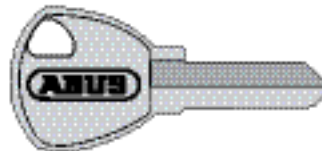

**90233**

Works with: 65/30 + 35, 64TI/30 + 35 New



**90190**

Works with: 65/15 L

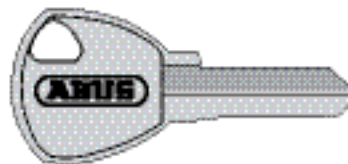

**90240**

Works with: 65/40 + 45 Old



**90200**

Works with: 65/15 R

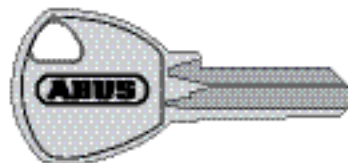

**90243**

Works with: 65/40 + 45, 64TI/40, T65, 70, 70AL

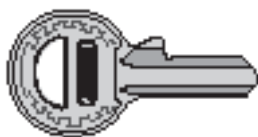

**90215**

Works with: 65/20

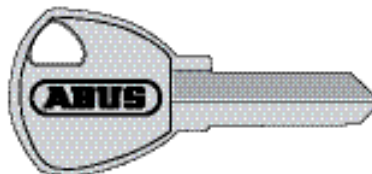

**90250**

Works with: 65/40 + 45, 64TI/40, T65, 70, 70AL

# Key Blanks

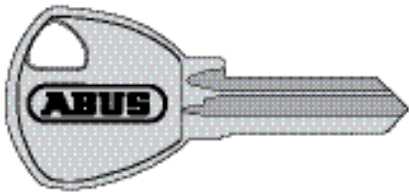

**90183**

Works with: 65/50 + 60, 64TI/50 + 60

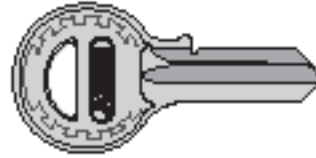

**90340**

Works with: T84MB/40 L

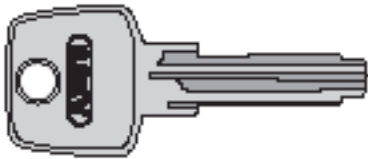

**90255**

Works with: 75/30 + 40, 25/70

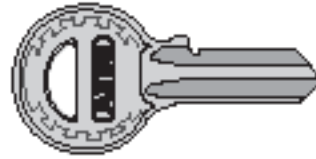

**90350**

Works with: T84MB/40 R

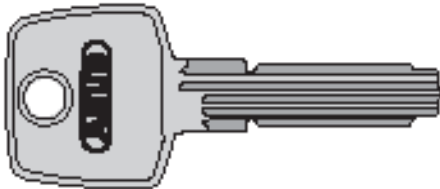

**90256**

Works with: 75/50 + 60

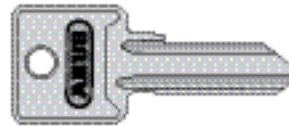

**90390**

Works with: 85/20 + 25 R

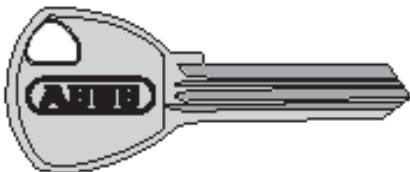

**90186**

Works with: 80TI/40 + 50

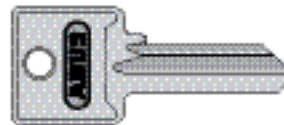

**90380**

Works with: 85/20 + 25 L

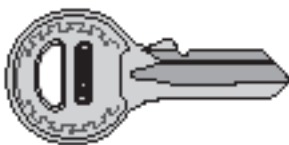

**90320**

Works with: T84MB/30 L

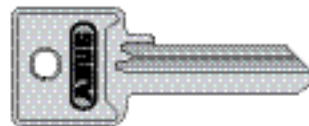

**90400**

Works with: 85/30 L

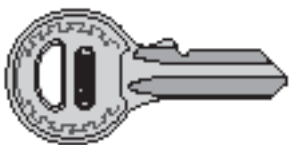

**90330**

Works with: T84MB/30 R

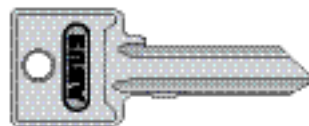

**90410**

Works with: 85/30 R

# Key Blanks

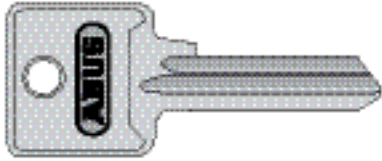

90420

Works with: 85/40 L, 82/63 + 70

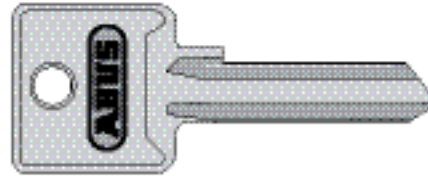

90450

Works with: 85/50+60 R, 82/90, 92/80

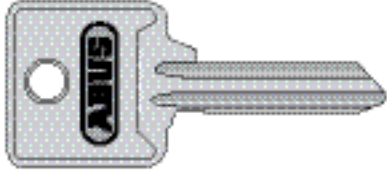

90430

Works with: 85/40 R, 82/63 + 70

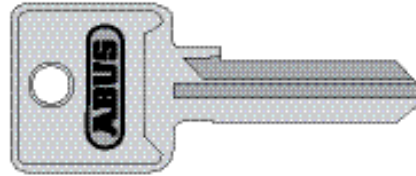

90590

Works with: 85/70 L

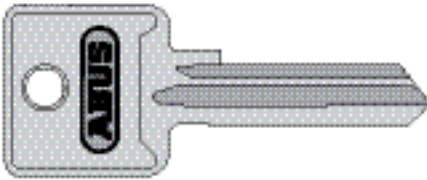

90440

Works with: 85/50+60 L, 82/90

# Terms and Conditions

## STANDARD TERMS & CONDITIONS

ABUS CANDA, LLC ("ABUS"), a division of the ABUS Group and all of its subsidiaries and related companies (future or currently existing) reserve the right to refuse an order, in its entirety or in part, when the credit of the Purchaser is judged not to be satisfactory in our absolute discretion. Furthermore, ABUS and its affiliates may refuse an order when the type or quantity of goods being requested does not conform to our ordering specifications.

The following conditions and terms incorporated herein constitute the entire agreement between the parties. Sales quotations, sales quotation requests, purchase orders or other forms of acknowledgment issued by the Purchaser that have contradictory terms and conditions do not bind ABUS or its affiliates to any other terms and conditions beyond those encompassed in this agreement. Only with separate written agreements written by ABUS or its affiliates and authorized by an ABUS representative may alternative terms and conditions be considered or referenced.

When ABUS accepts the Purchaser's purchase order, the Purchaser agrees that they accept the terms and conditions as described in this agreement regardless of the terms and conditions that may be specified in the Purchaser's purchase order. In the event when the Purchaser's purchase order terms and conditions and the terms and conditions specified in this agreement conflict, the Purchaser's terms and conditions will be disregarded and denied and the Purchaser agrees that this agreement shall constitute the entire agreement between the Purchaser and ABUS. In the event or circumstance that the enforcement of the terms and conditions of this agreement hereof is not conducted by ABUS or any other instrument, document, or alternative agreement relating to the goods being sold, such lack of enforcement will not waive, affect or reduce any right of ABUS in the future to require/enforce strict performance of such terms and agreements.

## PRICES

All prices are subject to change without advance notice and are not guaranteed. All orders received by ABUS are deemed submitted at applicable prices in effect at the time of shipment pursuant to the terms and conditions outlined below. Possession of this catalog, ABUS Price List or other officially authorized ABUS documents, sales literature, catalogs does not constitute an agreement to sell. We reserve the right to correct clerical and other types of errors at any time. All prices are stated in US dollars.

## TERMS

Decisions concerning the extension of trade credit are made by ABUS in its absolute sole discretion. Distributors/Purchasers who satisfy ABUS' ordinary credit criteria will be able to purchase products from ABUS at Net thirty (30) days. A service charge of 1% per month shall be imposed on the unpaid balance of any delinquent invoices. COD or Cash in Advance orders do not qualify for any term discounts. Furthermore, the Customer/Distributor/Purchaser shall be responsible for costs involving collections, court cost and or attorney's fees in association with the recovery of any overdue amounts.

## RETURNED CHECKS

NSF checks will be charged a \$30 returned check fee. Returned checks are required to be paid by money order, cashier's check, or credit card. ABUS reserves the right to revoke open terms and change the account to Credit Card Required if we receive more than two returned checks for an account in any 90 day time period.

## CREDIT HOLD POLICY

ABUS reserves the right to hold orders for any account that is past due.

## STATE RESALE TAX CERTIFICATE

ABUS is required by law to have a valid resale tax certificate on file for each customer that makes a tax-exempt purchase. It is very easy to confuse the Resale Tax Certificate with a sales tax license, registration, or resellers permit number. The Resale Tax Certificate applies to the purchase(s) of goods for resale and proves that sales tax does not need to be collected; the purchaser must collect sales tax when the goods are resold. There are state specific laws that must be followed. Unfortunately, there is no one form that can be used in all states. ABUS must have a Resale Tax Certificate for each dealer for each state, and may have multiple Resale Tax Certificates for a customer. Some Resale Tax Certificates expire, so ABUS must monitor the validity and be certain that Resale Tax Certificates on file are current.

## ACCOUNT CHANGES

For your protection, any changes to your business such as name, address, phone/fax number, contact personnel, or ownership must be submitted to ABUS in writing by a principal and then sent via fax or USPS to us.

## CHANGES & CANCELLATIONS

Changes to or cancellations of orders must be made in writing and delivered by email, fax or regular mail. Cancellations made after ABUS has issued an order acknowledgment are subject to ABUS approval, and are subject to a \$25 processing fee in addition to any cost incurred by ABUS as a result of the original order.

## QUOTATIONS

If and when ABUS chooses to provide an official sales quote, the quote will be valid for thirty (30) days. Complete shipment of the order must be accepted by the Purchaser within six (6) months from the date of issuance. Sale quote numbers (SO #'s) and possible project names must be referenced on the order. The sales quote is considered null and void if the Purchase Order does not reflect all of the product lines on the original sales quote or if the quantities for an item found in the quote deviate fifteen (15) percent or more. The Purchaser must request a new quotation.

Amendments, changes or modifications to an original sales quote will be accepted for up to thirty (30) days from the date of the original quote. All modifications must reference the original sales quote number. With the acceptance of the sales quote for the purchase of products, the Purchase agrees that the products or services being purchased will not be resold or transferred to any distributor not sanctioned/authorized by ABUS to sell its products. This includes all branches and affiliates of the distributor. Failure to adhere to this restriction may result in the distributor's loss in eligibility for quotes or services at ABUS' sole discretion.

## FREIGHT POLICY

ABUS will prepay freight on deliveries to customers provided the following conditions are met (customers in Alaska, Hawaii, Puerto Rico, and Canada are excluded and should contact ABUS USA, LLC for information regarding applicable freight charges):

1. The order must be for a minimum of \$750 to qualify for prepaid freight.
2. Payment of invoices is within terms. (i.e. freight will not be prepaid on orders to customers with past due invoices).
3. ABUS reserves and shall have the absolute right to select and employ the most economical carrier. If the customer specifies routing that results in higher freight costs, then ABUS' invoice will include the difference, which the customer agrees to pay.
4. All shipments are FOB (Freight On Board) ABUS US, Phoenix, AZ. Title of goods passes to customer upon delivery thereof by ABUS to the carrier or delivery service. Thereupon, the purchaser assumes fully the risk of loss.

## CLAIMS

All claims for shipping and/or invoicing differences must be submitted within 10 days of receipt of shipment. Upon delivery to or pickup by the carrier, title passes and shipments become the property of the customer.

The customer assumes the risk of and makes claims for any loss, shortage or damage in transit.

## RETURNS

Requests to return ABUS products should be made within 10 days from date of order and ABUS reserves the right to request date of manufacture and other product information. On goods returned for customer convenience, ABUS requires product be in new, resellable condition and in the original, unaltered packaging.

An RMA (Return Material Authorization) must be obtained from authorized personnel of ABUS before any product may be returned. RMA number must be clearly marked on the outside of the return package. Upon inspection by ABUS, a decision will be made to issue a credit for the ABUS product. This decision will be made solely by ABUS in accordance with the provisions of these Terms. Merchandise returned to ABUS in original unopened cartons is subject to a 15% restocking fee. Merchandise returned in an unsellable state (damaged blisters, product cards etc.) will be subject to an additional 20% repackaging fee.

Obsolete products will not be accepted for return. Transportation charges and insurance on all returned materials must be prepaid by the purchaser.

On goods returned for customer convenience, when the purchaser returns materials in compliance with these Terms which are accepted by ABUS, the purchaser may be issued a credit for 85% of the purchase price, with 15% charged by ABUS for handling and reprocessing.

Refused Orders – Orders refused for any reason will be charged a 15% restocking fee and all applicable freight costs incurred by ABUS will be charged to your account.

All refunds will be in the form of a merchandise credit, no cash refunds will be given.

Custom Pinning/Keying orders will be assessed a 25% re-stocking fee. All engraved locks are non-refundable.

## FULL WARRANTY

This warranty gives you specific rights, and you may have other rights which vary from state to state. This warranty applies to ABUS brand products only.

If an ABUS product fails to work properly due to a manufacturing defect, return it to ABUS postage prepaid, and we will return it repaired or replaced at our discretion. To obtain warranty service, please call 800.352.2287 or simply return the padlock prepaid along with receipt of purchase and all parts and keys if applicable to:

ABUS USA LLC  
23910 N. 19th Ave., #56  
Phoenix, AZ 85085-1850

ABUS products are warranted for a specific period of time from date of purchase. Commercial products are warranted for 2 years against manufacturing defects and ABUS reserves the right to replace or repair the product at its discretion. ABUS will return the repaired or replaced product to the original purchaser.

All products sold under the Vitess™ High Security Cylinder line will have a limited two (2) year warranty from the time that the original goods were transferred from the Purchaser. ABUS Vitess™ high security keys will have a lifetime warranty against manufacturing defects and breakage.

#### **REQUIREMENTS FOR COMBINATED AND UNCOMBINATED VITESS™ PRODUCTS:**

1. Keys shall be cut to the ABUS Vitess™ specifications required for the particular keyway and depth system and be original key blanks made by ABUS.
2. All pin lengths shall be selected according to prescribed ABUS Vitess™ requirements.
3. Original ABUS Vitess™ brand cylinders and cylinder components, including pi tumblers and key blanks, shall be used. We reserved the right to void any warranties or claims for warranty on the basis of using products or components that are not produced by ABUS USA, LLC or its affiliated ABUS sister companies.
4. ABUS will not pay for the cost of the repair performed, reinstallation or new installation of a new or existing keying systems or products. Furthermore, ABUS cannot be held liable for any related fees, loss of use or perceived loss of use or any other associated issues in terms of a warranty claim on the ABUS Vitess™ keying system. Written notice of a product or component part believed to be defective as covered by this warranty should be sent to ABUS and should include your name and address, an identification of the product or component part and a brief description of the defect. Upon receipt of such notice, ABUS will inform where to ship the product or component with prepaid shipping for inspection and in the event such inspection reveals a defect covered by this warranty, the product will be repaired and or replaced. ABUS and its affiliates reserve the right to replace products covered by this warranty that may be discontinued with what we deem as a suitable equivalent.

#### **LIMITATION ON LIABILITY**

To the extent permitted by law, ABUS and its agents and affiliates (collectively "ABUS Parties") shall not be responsible for, and the purchaser hereby assumes the risk of, and hereby releases ABUS for any damages or injury whatsoever (including, without limitation, incidental or consequential damages, damages for lost profits or business interruption, and punitive damages) caused by or related to any use of ABUS Products, regardless of any error, omission, interruption, defect, failure of performance, delay in operation or transmission, even if ABUS has been advised of the possibility of such damages. If, notwithstanding the foregoing limitations, ABUS has any liability to the purchaser despite the foregoing limitations, the purchaser agrees that the ABUS' total liability to the purchaser for all losses, damages, and causes of action, whether in contract, equity, tort (including without limitation, negligence and gross negligence), or otherwise, will not exceed the amount the purchaser paid to ABUS for the ABUS products. Any action or arbitration brought against the ABUS pertaining to or in connection with the ABUS Products must be commenced and served upon ABUS within one (1) year after the date the cause of action arose, and not thereafter. Failure to abide by such deadline will constitute a complete defense for the ABUS Parties to the purchaser's claims.

#### **NO THIRD PARTY LIABILITY**

If the purchaser uses the ABUS Products on behalf of others or provides to others any products referenced herein, the ABUS Parties shall have no liability to such persons whatsoever, and the purchaser agree to defend and indemnify the ABUS Parties from any and all claims and demands asserted against them, and from any legal fees, costs and other expenses that the ABUS Parties incur therewith.

#### **GOVERNING LAW & JURISDICTION**

These Terms are governed by the laws of the State of Arizona, U.S.A. but without regard to its principles of conflict of laws. For any interpretational disputes relating to, or claims arising from, these Terms, the purchaser agrees to the exclusive jurisdiction of the Superior Court of Arizona in Maricopa County, provided, however, that such restriction shall not apply to legal actions initiated or brought by ABUS. Upon request by ABUS, all disputes concerning and claims arising from the foregoing shall be referred to binding arbitration in Maricopa County, Arizona by an arbitrator selected only by the Superior Court of Arizona in Maricopa County. The purchaser hereby waives its right to a jury with regard to claims against the ABUS Parties hereunder. The language used in these Terms shall not be construed.

# 90 Years of Innovation

**“Do what you love to do.”** Based on this statement, August Bremicker took the chance to start his own business in the small town of Volmarstein, Germany in 1924. With the vision to create products that protect peoples' lives and their belongings, the production of the first padlocks started in the cellar of the family home. Today, a globally acting company group has emerged from the family enterprise.

Tireless efforts, richness of ideas, know-how in development, manufacturing and sales are the cornerstone of the success of the family business which today is led by the third and fourth generation.

The basis of ABUS's security competence lies in the comprehensiveness of their product offering for security across multiple platforms. This program has already been expanded by the Recreational Security division which focuses on products for bikes, motorbikes, marine products, etc. and is further expanded by sister companies ABUS Security-Center, focusing on electronic security, ABUS Pfaffenhain, manufacturing high-security cylinders, and ABUS Seccor, specializing in electronic access control.

For years, ABUS focused on bringing security to many different applications across the globe. With an increase in industrialization in the U.S., ABUS identified a new need for security solutions in the form of safety lockout. In 2005, ABUS produced its first padlock specifically designed for safety applications.

Over the next decade, ABUS continued to learn more about the safety lockout business and the need for safety solutions in so many different places all over the world. With the implementation of regulations and rules related to safety in the workplace, ABUS sought out to develop a comprehensive safety program and, in 2014, launched a full line of safety lockout devices to compliment its offering of safety padlocks.

With security solutions that are more and more interconnected, we react to the rising expectations of our customers. Our main focus is the brand quality of ABUS. That means, to work in a team as a worldwide brand manufacturer and to set the same benchmarks no matter where in the world we operate.



„ A B U S ”



**ABUS** | Canada  
**www.abus.com**

---



Security Tech Germany

Toronto Head Office  
6520 Northam Drive  
Mississauga, ON, L4V 1H9  
P: 905-673-2287  
TF: 1-855-287-2287  
F: 905-676-1924  
sales@abuscanada.com

Montreal Branch Office  
2073 Chartier  
Dorval, QC H9P 1H3  
P: 514-613-1707  
TF: 1-855-287-2287  
F: 514-631-0494  
sales@abuscanada.com

Due to a policy of continental development, ABUS reserves the right to modify technical details & colors. E&OE ABUS © 2018

